

We create ambience.

SIBU world

09/2022



SIBU | DESIGN

WIR MACHEN RÄUME LEBENDIG. *WE CREATE AMBIENCE.*

Mit unserer Laminierkunst vereinen wir Schönheit und Funktion, indem wir verschiedenste Materialien miteinander verbinden. Kundenorientiert und flexibel fertigen wir Designelemente in herausragender Qualität und sorgen so für unverwechselbare Raumerlebnisse.

With our art of laminating, we unite beauty and function by combining different materials. Always customer-oriented and flexible, we manufacture design elements of outstanding quality and thus ensure unique spatial experiences.



ÜBER UNS ABOUT US

SIBU DESIGN GmbH & Co KG

Gegründet 1984 / 55 Mitarbeiter / über 200 lagernde Dekore

SIBU DESIGN ist führender Hersteller von hochwertigen Wandpaneelen für den Innenbereich. Diese werden speziell für Innenausbau, Möbelbau, Shop, Fashion, Gastronomie/Hotellerie, Architektur und Display entwickelt.

SIBU DESIGN punktet mit trendigen Dekoren, qualitativ hochwertiger Verarbeitung, sowie mit kurzen Lieferzeiten und bietet zusätzlich hohe Flexibilität bei Just-in-Time Projekten.

Nachhaltigkeit steht dabei immer an erster Stelle, von der strengen Auswahl der Rohstoffe, über modernste Fertigungsverfahren bis hin zur zuverlässigen Lieferlogistik.

SIBU DESIGN produziert ausschließlich in Österreich und garantiert dabei 100% PVC-freie Oberflächen.

SIBU DESIGN GmbH & Co KG

Founded in 1984 / 55 employees / more than 200 decors in stock

SIBU DESIGN is a leading manufacturer of high-quality wall panels for interior applications, such as interior design for shops, hotels, restaurants, for furniture production as well as display and architectural useage.

SIBU DESIGN convinces with trendy decors, high-quality processing as well as short delivery times and offers high flexibility for just-in-time projects.

Sustainability always comes first: from the strict selection of raw materials to the most modern manufacturing processes and reliable delivery logistics.

SIBU DESIGN produces exclusively in Austria and guarantees 100% PVC-free surfaces.



SIBU DESIGN VEREINT DESIGN UND FUNKTION

Wir antizipieren aufkommende Trends und nehmen diese in unserer Produktentwicklung auf.

Diese Trends verbinden wir mit funktionellen Eigenschaften, um neben der optischen auch die technischen Anforderungen unserer Kunden zu erfüllen:

- Langlebigkeit durch besonders hohe Abriebwerte
- Leichte Verarbeitung mit Standard-Werkzeugen
- Zeitsparende Installation durch geringes Gewicht und große Formate
- Einhaltung regulatorischer Vorgaben, wie Feuchtigkeits- oder Brandbeständigkeit
- Schnelle Verfügbarkeit aufgrund eines großen Lagerprogrammes und optimierter Abläufe
- Bester Service mit lokaler Produktion und engagierten Mitarbeitenden
- Einfacher Einsatz auf der Baustelle durch Vorkonfektion: auf Maß geschnitten, selbstklebend ausgestattet, gestanzt, gerollt, verformt oder auf MDF/HDF/etc. verpresst.

Ebenso fertigen wir individuelle, kundenspezifische Designs und verfügen über einen eigenen Formenbau, CNC-Fräsen, Stanzen, ein großes Netzwerk an Zulieferern und streben stets danach (T)Räume lebendig zu machen.

SIBU DESIGN COMBINES DESIGN AND FUNCTION

We anticipate emerging trends and incorporate them into our product development.

We combine these trends with functional properties in order to meet not only the visual but also the technical requirements of our customers:

- Longevity due to a particularly high abrasion resistance
- Easy processing with standard tools
- Time-saving installation due to lightweight materials and large formats
- Compliance with regulatory requirements such as moisture or fire resistance
- Fast availability due to a large stock program and optimized processes
- Best service with local production and committed employees
- Easy installation on the construction site by delivering: cut to size, equipped with a self-adhesive reverse side, punched, rolled, shaped or pressed on MDF / HDF / etc.

We also manufacture individual, customer-specific designs and have our own mold construction, CNC milling, punching, a large network of suppliers and always strive to create ambience.



PRODUKTGRUPPEN *PRODUCT GROUPS*

FABRIC-LINE (FL)

LEATHER-LINE (LL)

DECO-LINE (DM)

MULTISTYLE (MS)

STRUCTURE-LINE (SL)

OPACO-LINE (OL)

SIBUGLAS (SG)

TRANSLUCENT-LINE (TL)

WOOD-LINE (WL)

NATURE-LINE

ANTIGRAV

BATH ART MATT (BA)

PRODUKTAUFBAU

PRODUCT STRUCTURE

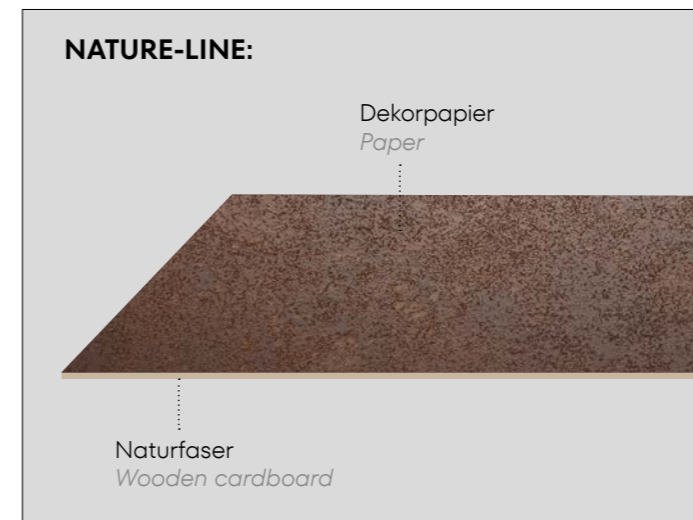
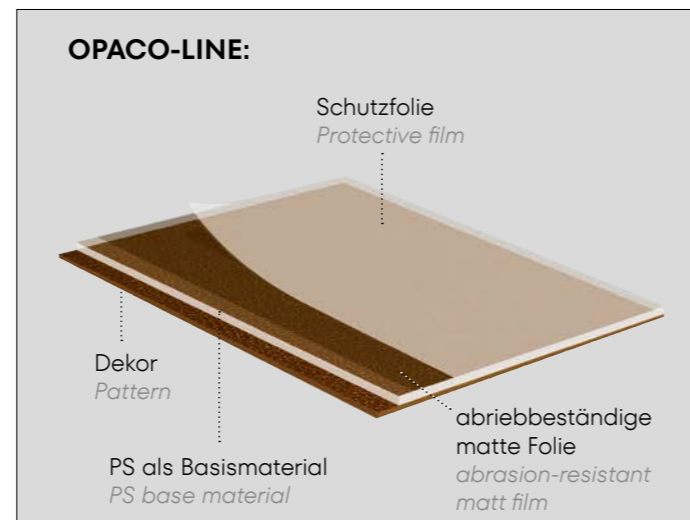
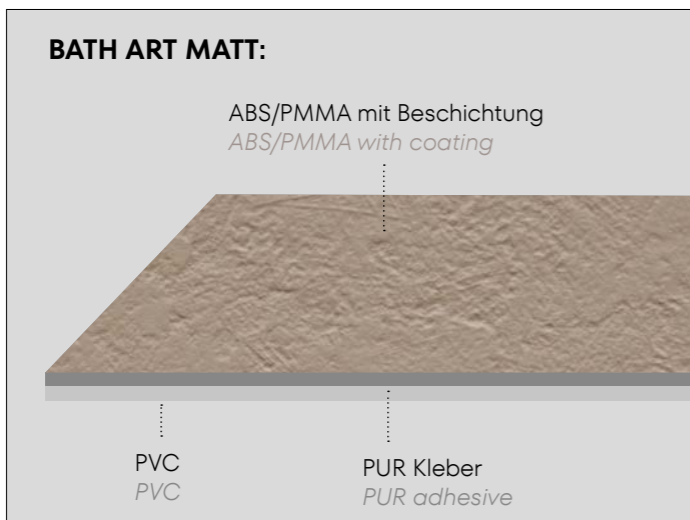
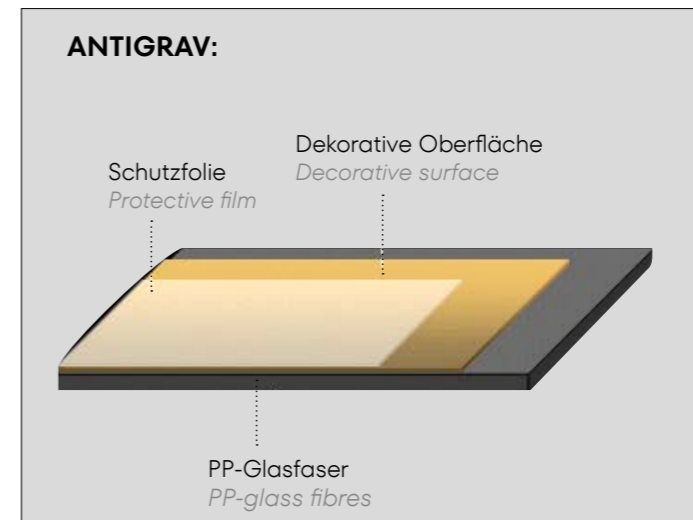
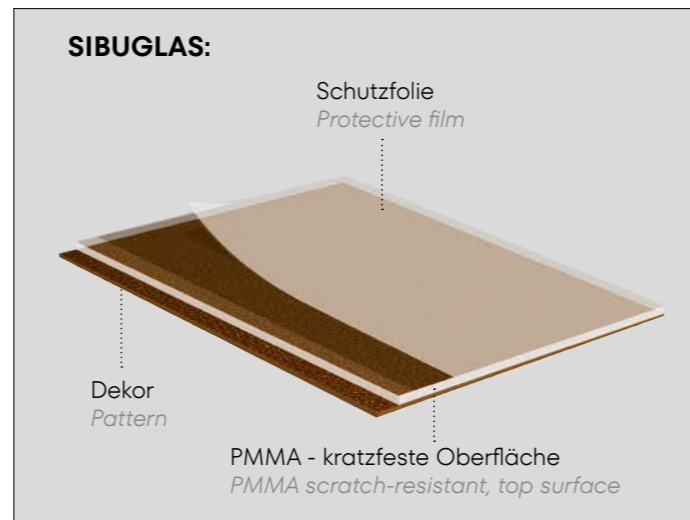
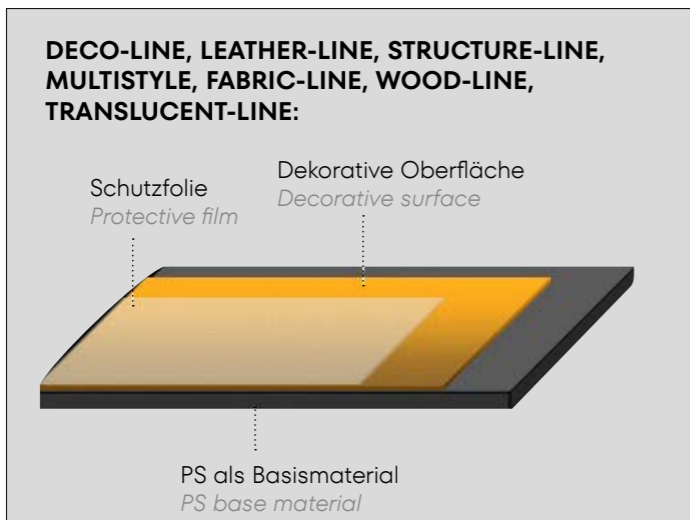

FORMAT DIMENSIONS

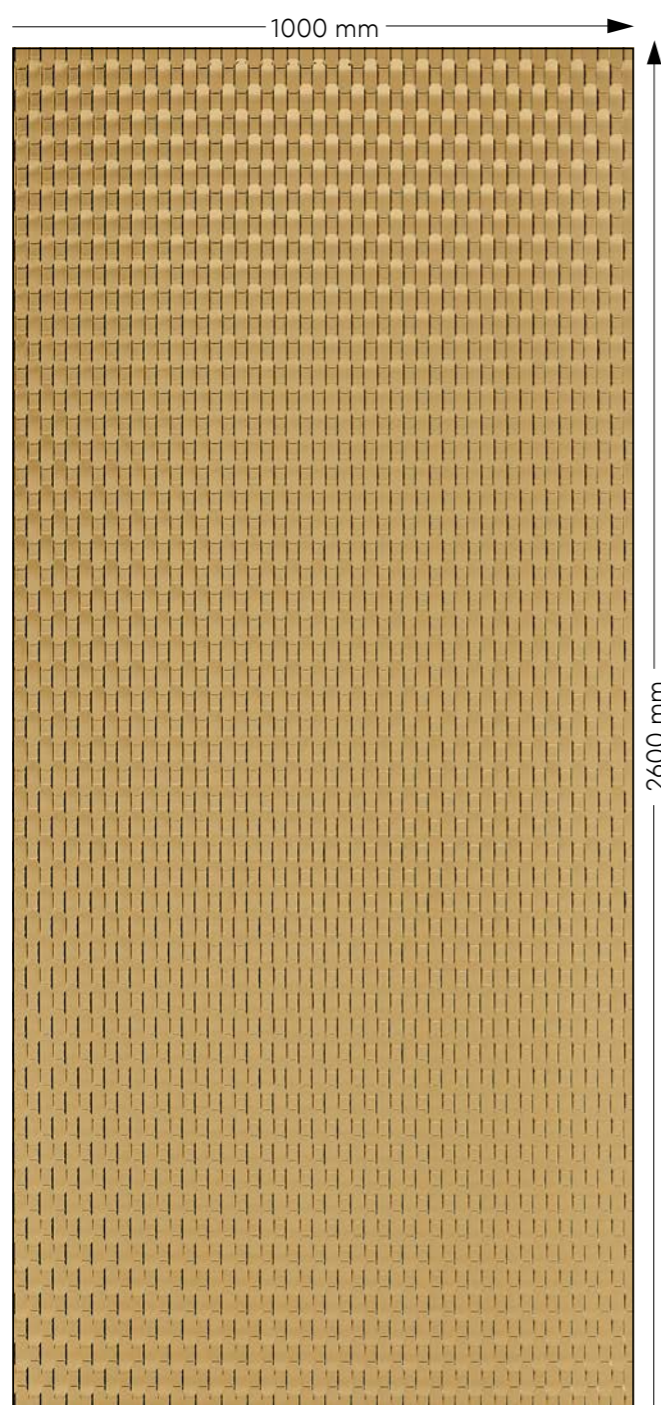

Standard-Lagerprogramm: Format: 2600x1000 mm *Standard stock programme:* Dimensions: 2,600 x 1,000mm



Formatproduktion und Zuschnitte möglich
Format production and cut-to-size products possible

VERARBEITUNGSMÖGLICHKEITEN

PROCESSING POSSIBILITIES

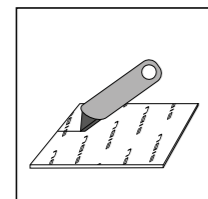

Schneiden
Cutting

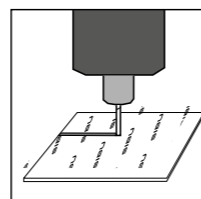

Fräsen
Milling

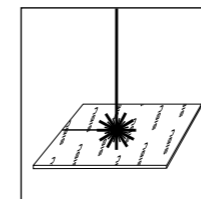

Laserzuschnitt
Laser cutting

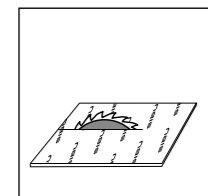

Sägen
Sawing

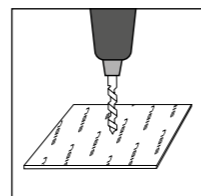

Bohren
Drilling

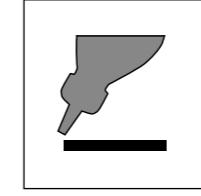

Verpressen
PVA Vorbehandlung
Press bonding
PVA pretreatment

Detailliertere Infos finden Sie im OVERVIEW und unter: www.sibu.at/service/verarbeitungshinweise

More detailed information can be found in our SIBU OVERVIEW and under: www.sibu.at/en/service/processing-information

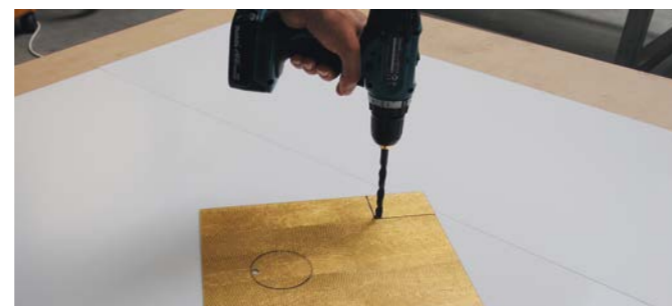

VERARBEITUNGSHINWEISE PROCESSING INFORMATION

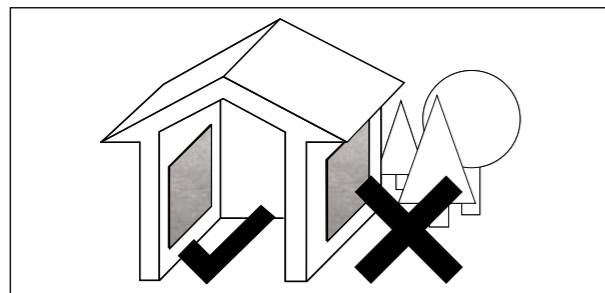

Anwendung nur im Innenbereich
Only for interior application

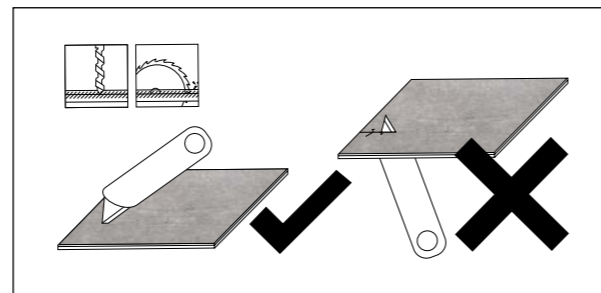

Bearbeitung der Designplatten immer
von der Oberseite
*Processing of the design panel always
from the top side*

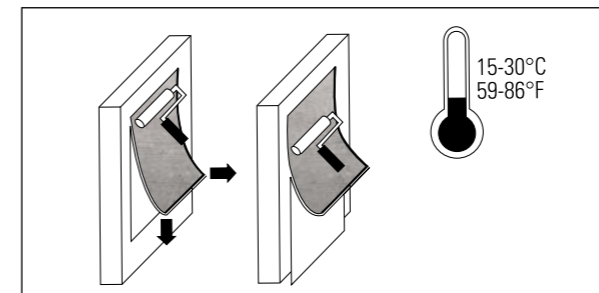

Die Dekorplatten müssen akklimatisieren.
The design sheets should be acclimatized

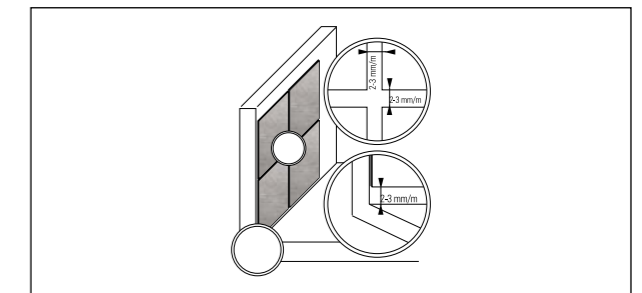

Generell ist an den Plattenrändern eine
ca. 2–3 mm große Dehnfuge einzuhalten!
*As a rule, an approx. 2-3 mm expansion
joint is to be left along the sheet edges!*

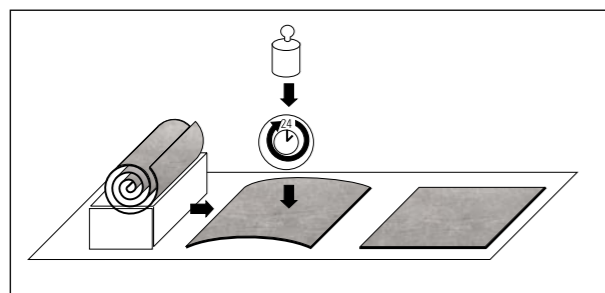

Gerollt angelieferte Designplatten sollten
mind. 24 Stunden flach aufgelegt werden,
Beschweren verbessert die Planlage.
*Patterned sheets delivered in rolled
form should be kept flat for a minimum
of 24 hours. Weighting down improves
evenness.*

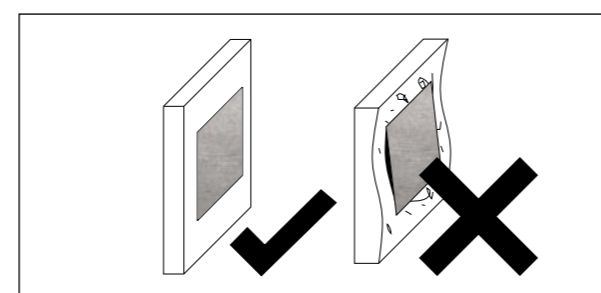

Der Untergrund muss frei von losen Teilen,
trocken, glatt, staub-, schmutz-, fett-,
wachs- und silikonfrei sein.
*The surface should be dry and flat, free
from loose parts, dust, dirt, grease, wax
and silicone.*

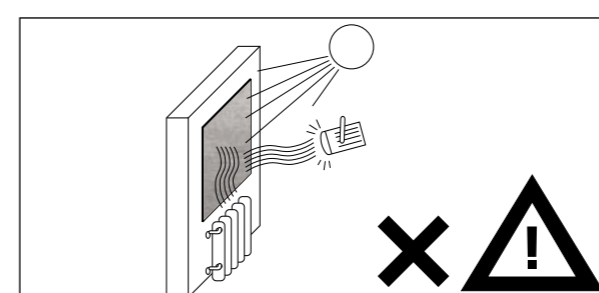

Nicht empfohlen zur Anwendung in
der Nähe offenen Feuers oder starken
Hitzequellen.
*Not recommended for use near open
fires or strong heat sources.*

**Detailliertere Informationen
finden Sie in unseren
Verarbeitungshinweisen
unter www.sibu.at**

*More detailed information
on our processing instructions
can be found on www.sibu.at*



FABRIC-LINE

Die FABRIC-LINE - raffiniert und zeitgemäß - bietet ein vielfältiges Sortiment von unterschiedlichen Textilien. Das Zusammenspiel der haptischen Beschaffenheiten, Strukturen und Farben schaffen ein einzigartiges multisensorisches Erlebnis.

Die FABRIC-LINE als ANTIGRAV kann dehnfugenfrei verarbeitet werden und wirkt sich zusätzlich positiv auf die Raumakustik aus.

Die FABRIC-LINE überzeugt mit:

- › Fortlaufenden Designs
- › Stimmigen Farb- und Designkombinationen
- › Wertiger Haptik

Erhältlich:

- › In selbstklebender oder magnetischer Ausführung
- › Auf ANTIGRAV – dehnfugenfrei, extrem leicht, formstabil

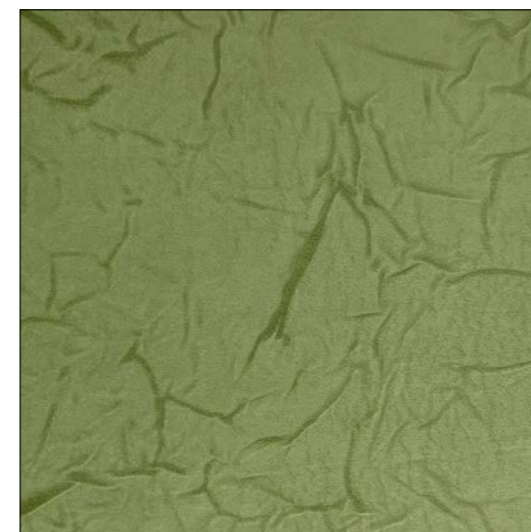

FL CREPA VELVET Avocado

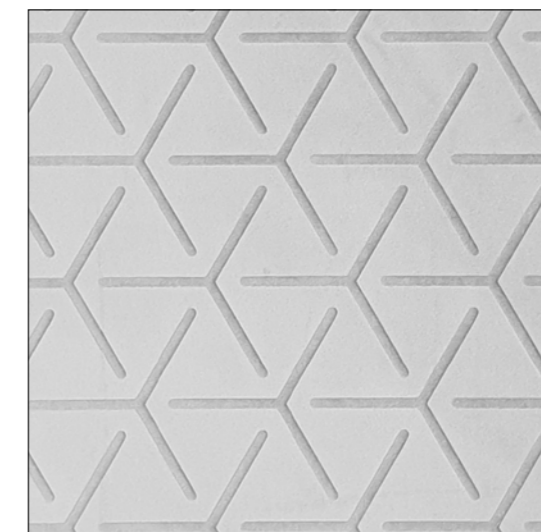

FL CUBE VELVET Pearl

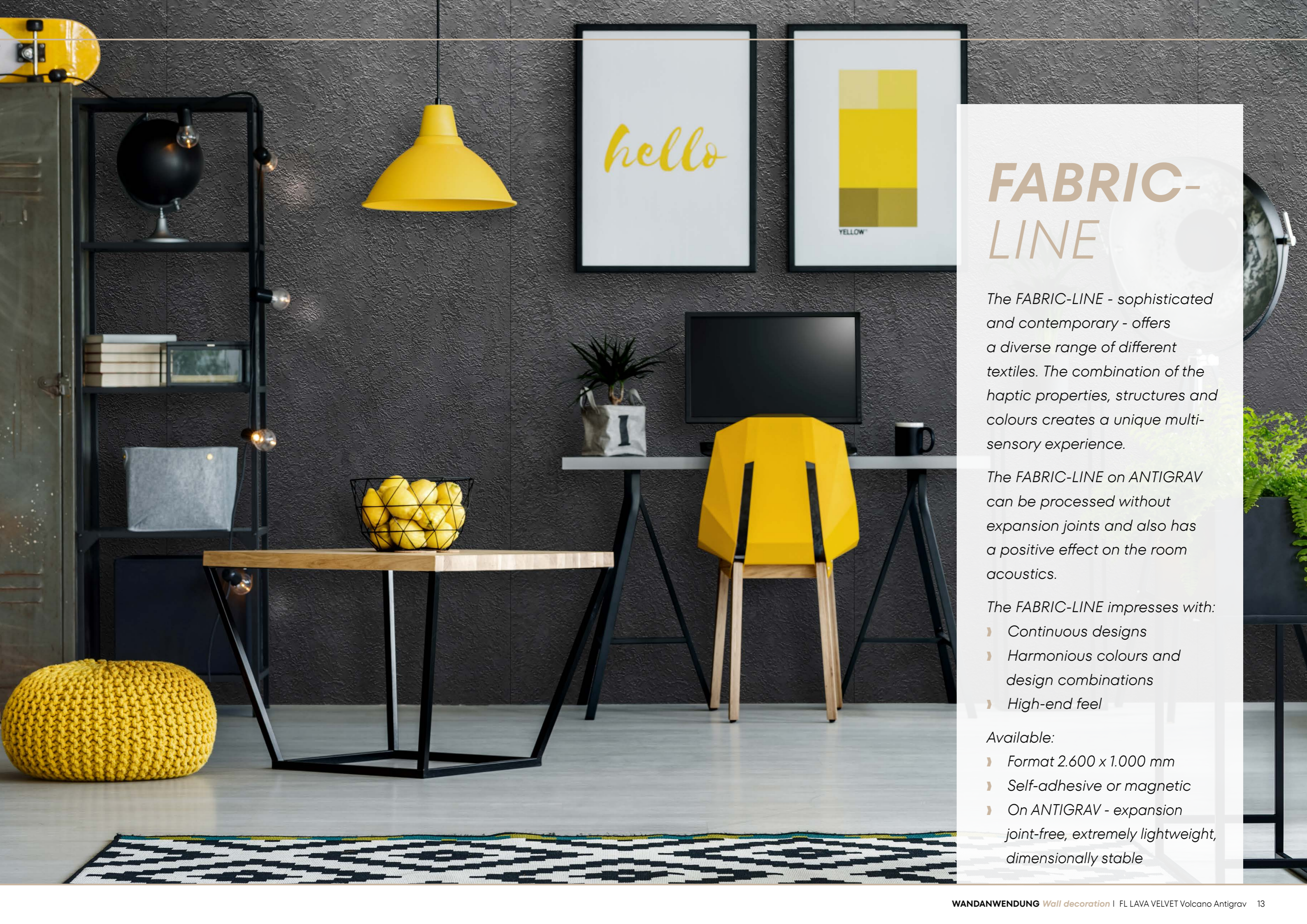

FABRIC-LINE

The FABRIC-LINE - sophisticated and contemporary - offers a diverse range of different textiles. The combination of the haptic properties, structures and colours creates a unique multi-sensory experience.

The FABRIC-LINE on ANTIGRAV can be processed without expansion joints and also has a positive effect on the room acoustics.

The FABRIC-LINE impresses with:

- › Continuous designs
- › Harmonious colours and design combinations
- › High-end feel

Available:

- › Format 2.600 x 1.000 mm
- › Self-adhesive or magnetic
- › On ANTIGRAV - expansion joint-free, extremely lightweight, dimensionally stable



LEATHER-LINE

Edle Ledernarbungen, besondere Ziernähte, exotische Reptiliendekore – und das alles vegan!

Eine Vielzahl an Designs und Oberflächen in topaktuellen Farben, alles in PVC-freier Qualität - so präsentiert sich die LEATHER-LINE.

- › Vegane Kunstlederoberflächen
- › Trendige Designs und Farben
- › Wertige Haptik
- › Glattes und strukturiertes Dekor
- › 100% PVC-frei
- › PVA-verklebbar
- › Magnetisch erhältlich

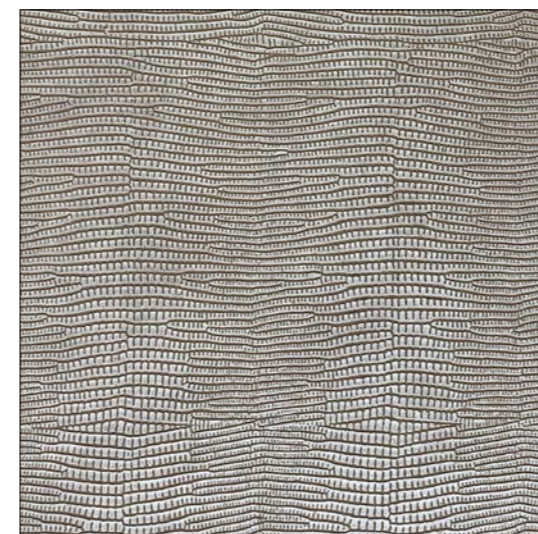

LL LEGUAN Silver

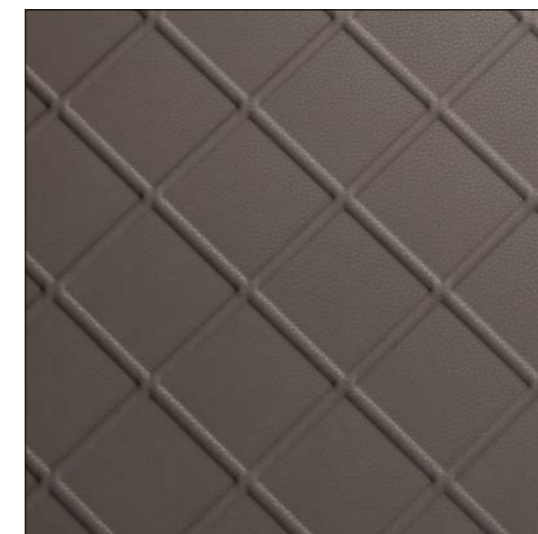

LL CORD Dove Tale



LEATHER- LINE

Exclusive leather grains, special decorative stitchings, exotic reptile decors - all of it strictly vegan!

Our unique synthetic leather surfaces outshine other products.

LEATHER-LINE offers a diversity of designs and top surfaces in highly fashionable colours and all in PVC-free quality.

- › *Vegan synthetic leather surfaces*
- › *Stylish designs and colours*
- › *High quality haptics*
- › *Smooth or structured decors*
- › *100% PVC-free*
- › *Suitable for bonding with PVA*
- › *Also available in magnetic version*

DECO-LINE

Das DECO-LINE Lieferprogramm umfasst brillante Spiegel- und Metallic-Oberflächen, sowie trendige Metallstrukturen. Ob Display oder Druck, Möbel-, Messe- und Ladenbau - im dekorativen Bereich sind DECO-LINE Produkte das Nonplusultra.

Zusätzlich bieten wir das DECO-LINE Programm in abriebbeständiger Oberflächenqualität an.

- › Spiegel-, Metall- und Holzoptik
- › Trendige Designs und Farben
- › Problemlos bedruckbar
- › Viele Produkte in schwerentflammbarer Ausführung
- › Magnetisch erhältlich



DM Gold brushed matt AR



DM LUXURY Bronze

DECO- LINE

The DECO-LINE programme includes brilliant mirror and metallic top surfaces, as well as stylish metal structures.

Irrespective of whether they are used for display, printing, furniture, trade fair or shop fitting purposes, DECO-LINE products represent the ne plus ultra.

In addition, DECO-LINE products are also available with abrasion-resistant surfaces.

- › *Mirror, metal and wood looks*
- › *Fashionable designs and colours*
- › *Problem-free printing*
- › *Many products supplied in a flame-retardant version*
- › *Also available in magnetic versions*



MULTISTYLE

Das MULTISTYLE Lieferprogramm beinhaltet Spiegel- und Metallicoberflächen in edler Mosaik-Optik. MultiStyle Produkte zeichnen sich durch ihre extreme Flexibilität aus und sind dadurch individuell einsetzbar - selbst Untergründe mit Radien sind für unsere Mosaikspiegel kein Problem.

MULTISTYLE - ein Muss im Display- und Dekorationsbereich!

- › Flexible Mosaikspiegel
- › Angesagte Ritzungen
- › Problemlos digital bedruckbar
- › Ein absoluter Eyecatcher
- › Ideal für Rundungen
- › Magnetisch erhältlich
- › Standardformat: 980x980mm (auch im Format 2600x1000mm lieferbar!)



□ MS 10x10 flex Classic Silver



□ MS 20x20 flex Classic Silver

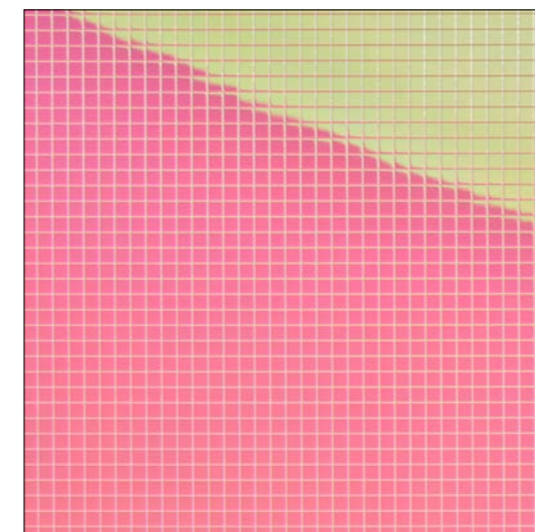

MS 5x5 flex Classic Hollywood

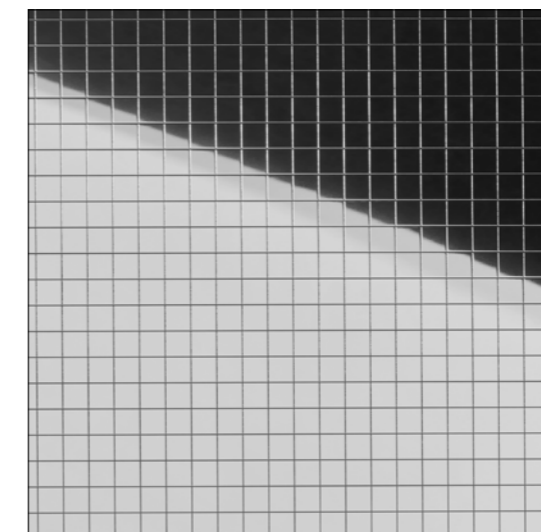

MS 10x10 flex Classic Silver

MULTI-STYLE

The MULTISTYLE programme consists of mirror and metallic top surfaces with a stylish mosaic appearance. MultiStyle products are characterised by their extreme flexibility. They can therefore be used in a highly individual manner and even be applied to curved surfaces without any problems.

MULTISTYLE is a must in the display and decoration area!

- › Flexible mosaic mirrors
- › Carvings
- › Problem-free digital printing
- › An absolute eye-catcher
- › Ideal for rounded surfaces
- › Available in magnetic versions
- › Standard format: 980x980mm, can also be supplied in a 2.600 x 1.000mm format!



□ SL CRASHED Silver

Photo: fotolia.com

STRUCTURE-LINE

Die STRUCTURE-LINE ist der strukturierte Hingucker: Dreidimensionalität vereint mit stimmigen Farbkombinationen schaffen ein multisensorisches Erlebnis. Ob Oberflächenoptiken in Beton, Vintage, Reptilien, Metall oder Holz - in der STRUCTURE-LINE ist für jeden Geschmack das Passende dabei.

- › Designs mit Struktur
- › Vintage-Optik
- › Reptilien-Optik
- › Metall-Optik
- › Magnetisch erhältlich



SL CREPA Snow White matt

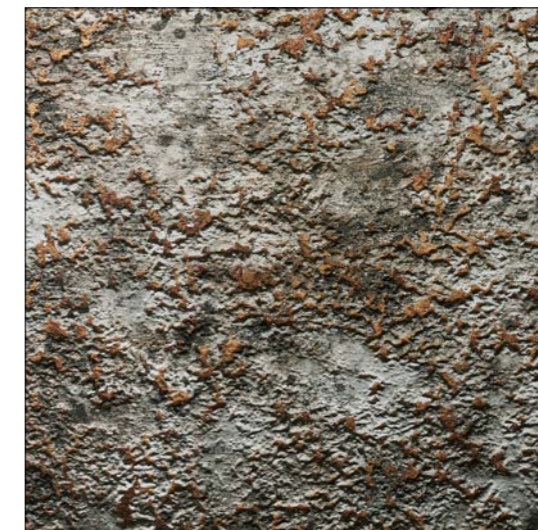

SL LAVA VINTAGE Copper



STRUCTURE-LINE

The STRUCTURE-LINE is our structured eye-catcher. No matter the surface requirement, may it be concrete, vintage, reptilian, metallic or wood - our STRUCTURE-LINE offers the perfect solution.

- › *Designs with a structure*
- › *Vintage look*
- › *Reptilian look*
- › *Metallic look*
- › *Can be supplied in magnetic versions*

OPACO-LINE

Seidenmatte Designoberflächen, kombiniert mit einer ausgezeichneten Abriebbeständigkeit, machen die OPACO-LINE unverzichtbar für Innenräume mit hohem Designanspruch.

Die OPACO-LINE überzeugt mit:

- › Langlebigkeit durch extrem abriebbeständige Oberflächen
- › Edle und matte Steindekore
- › Seidig-mattem Soft-Touch-Effekt

Erhältlich:

- › In selbstklebender oder magnetischer Ausführung
- › Auf Wunsch mit passenden Profilen

□ OL MARBLE Black matt AR



OL MARBLE Alpine matt AR



OL GENESIS White matt AR



OPACO- LINE

Semi-gloss design surfaces combined with an excellent abrasion resistance make OPACO-LINE essential for interiors with high design demands.

The OPACO-LINE impresses with:

- › *Longevity thanks to extremely abrasion-resistant surfaces*
- › *Noble and matt stone decors*
- › *Silky matt soft-touch effect*

Available:

- › *In the format 2.600 x 1.000 mm*
- › *In self-adhesive or magnetic versions*
- › *With matching profiles on request*

SIBUGLAS

Revolutionäre Tiefenwirkung mit höchster Abriebbeständigkeit für einzigartige Designobjekte.

SIBUGLAS-Produkte sind extrem abriebbeständig (AR+)

- › Acrylglas
- › Hochglanzoberflächen
- › Extreme Tiefenwirkung
- › Extrem abriebbeständig
- › Magnetisch erhältlich



SG LUXURY Bronze AR+



SG MARBLE Black AR+

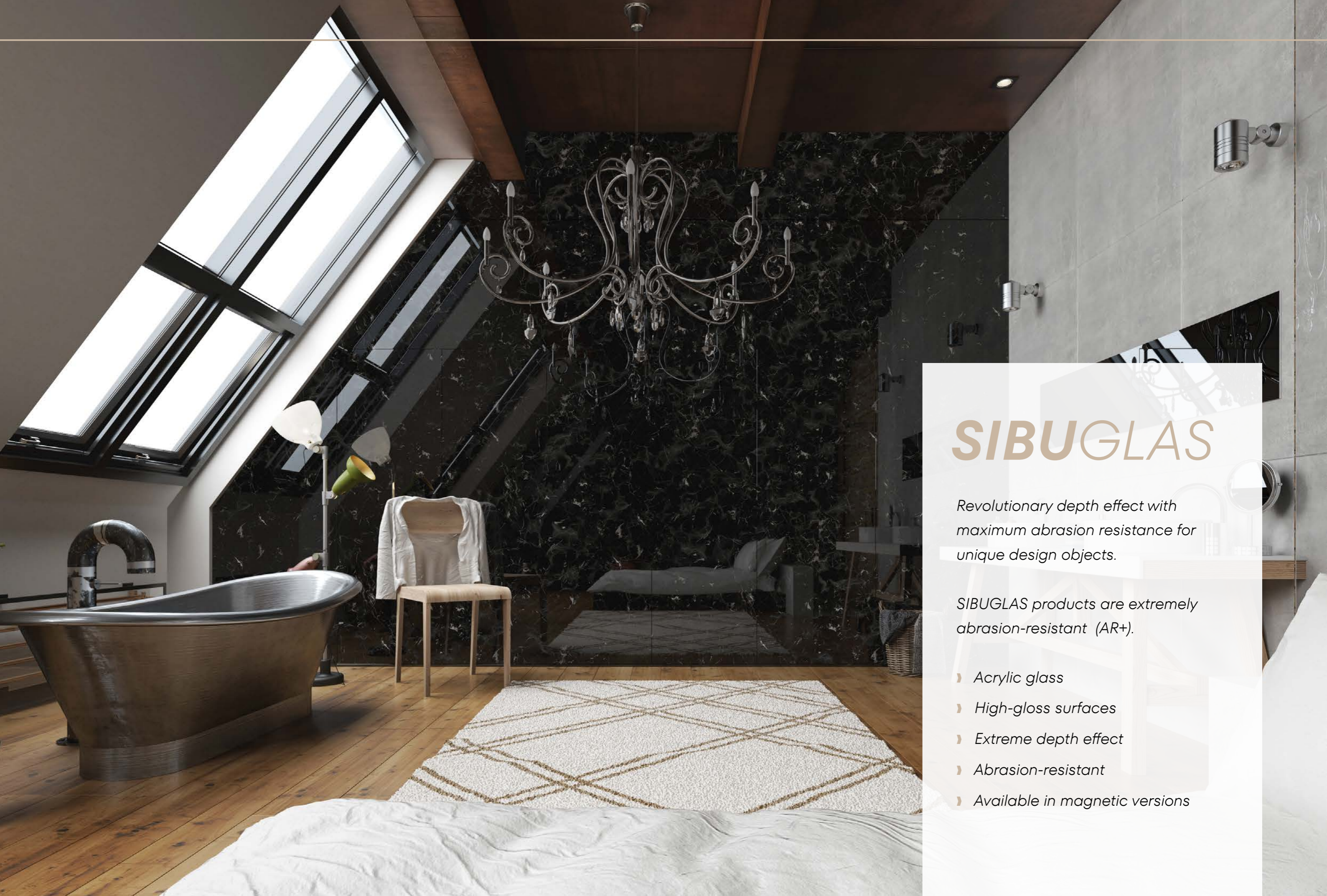

SIBUGLAS

Revolutionary depth effect with maximum abrasion resistance for unique design objects.

SIBUGLAS products are extremely abrasion-resistant (AR+).

- › Acrylic glass
- › High-gloss surfaces
- › Extreme depth effect
- › Abrasion-resistant
- › Available in magnetic versions

SIBUGLAS / OPACO-LINE BEARBEITUNG *PROCESSING*

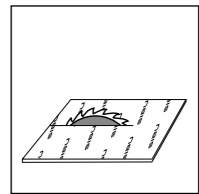

Sägen
Sawing

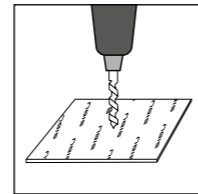

Bohren
Drilling

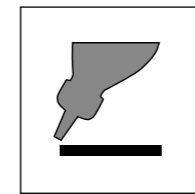

Verpressen
PVA Vorbehandlung
Press bonding
PVA pretreatment

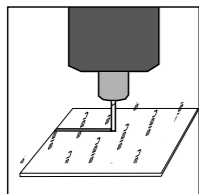

Fräsen
Milling

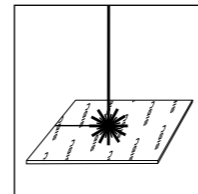

Laserzuschnitt
Laser cutting

Detailliertere Infos finden Sie im OVERVIEW und unter: www.sibu.at/sibuglas-opaco-line-verarbeiten

More detailed information can be found in our SIBU OVERVIEW and under: www.sibu.at/en/processing-of-sibuglas-opaco-line

SIBUGLAS / OPACO-LINE selbstklebend verarbeiten

SIBUGLAS / OPACO-LINE application as self-adhesive product

SIBUGLAS / OPACO-LINE verpressen

SIBUGLAS / OPACO-LINE press bonding

SIBUGLAS / OPACO-LINE

selbstklebend auf Holzträger
self-adhesive on wood based sheets

- › Klebstoffabdeckung abziehen und auf Holzträgerplatte aufkleben (Gummiroller) - kein Gegenzug notwendig.
- › Auf Endformat zuschneiden und Kanten aufbringen.
- › Mit elektrischer Handoberfräse Rundkante exakt bis zum Übergang abfräsen.

- › Remove the adhesive cover and bond the sheet onto the wooden panel (rubber roller) - no balancing sheet necessary.
- › Cut to the required dimensions and apply the edging.
- › Using an electrical manual router, mill a rounded edge exactly up to the point of transition from the transparent PMMA layer to the structured layer.

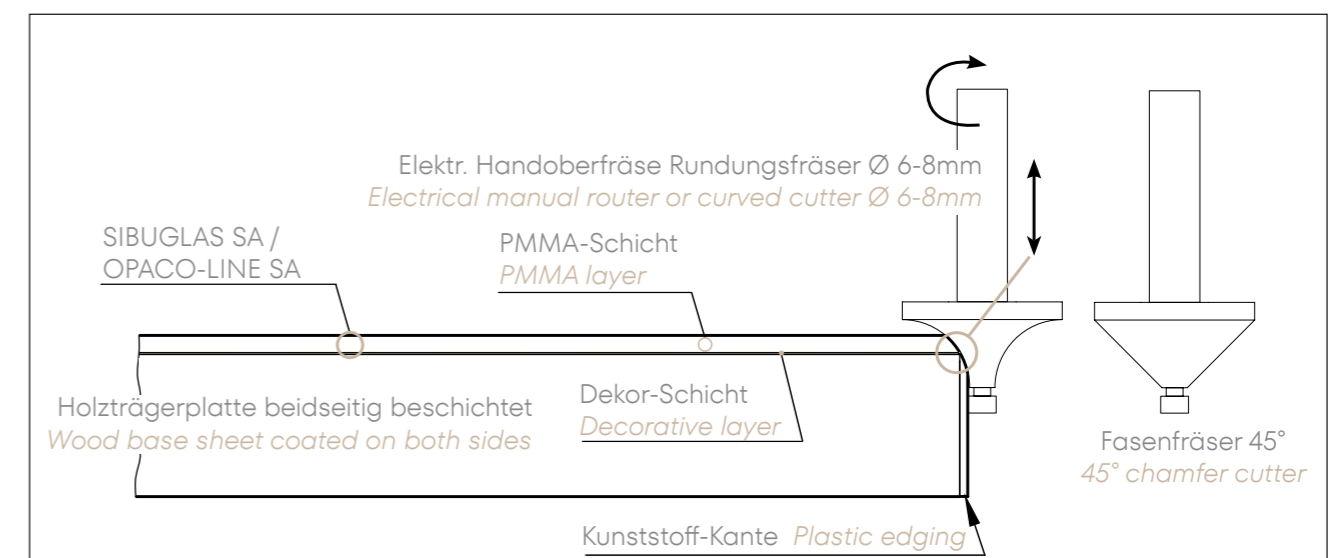

BESCHREIBUNG – AUFBAU

DESCRIPTION – STRUCTURE

SIBUGLAS / OPACO-LINE Dekorplatte _____
SIBUGLAS / OPACO LINE

PVA-Weißleim *PVA white glue* _____

Holzträgerplatte *Wood based sheet* _____

Mindeststärke 16 mm! *minimum thickness of 16 mm!*
Bei größeren Formaten stärkere Holzträgerplatten verwenden!
Use thicker wood based sheets for larger formats!

PVA-Weißleim *PVA white glue* _____

Gegenzugplatte *Balancing sheet* _____

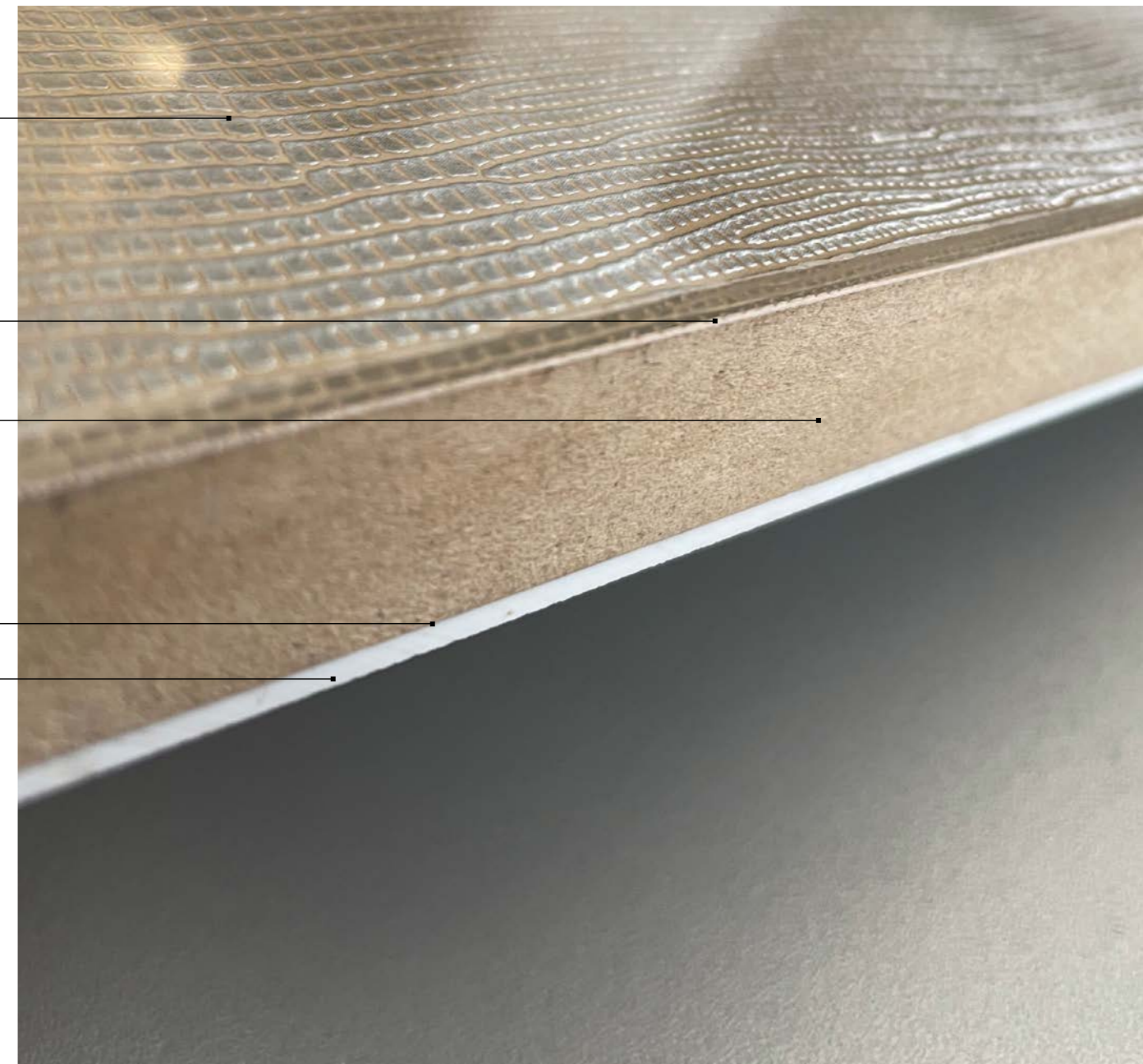

SIBUGLAS / OPACO-LINE verpressen *pressed*

Beide Rückseiten (Dekor und Gegenzug) werden mittels Leim-Roller mit PVA-Weißleim möglichst gleichmäßig, vollflächig getränkt und umgehend auf beide Seiten der saugenden Holzträgerplatte aufgelegt. Anschließend kommt der Verbund in die Plattenpresse.

Both reverse sides (design and balancing sheet) are saturated with PVA white glue as evenly and quickly as possible using a roller. They are then laid on both sides of the absorbent wood based sheet and this composite is subsequently placed in a sheet press.



TRANSLUCENT-LINE

Durchleuchtbare Designs für strahlende Akzente und optische Täuschungen. Die gefrästen Konturen der Designplatten lassen sich exakt hinterleuchten und schaffen so verschiedene Stimmungen und Raumerlebnisse. Dabei sind die Möglichkeiten durch individuelle Fräsungen grenzenlos.

Erhältlich in:

- › Verschiedensten Designs und Konturen
- › Nicht klebender und selbstklebender Ausführung

Leuchtmittel: LED, Leuchtstoffröhren

INDIVIDUELLE LICHTMOTIVE MÖGLICH.

Jegliche Schriftzüge, Formen und Designs sind problemlos realisierbar. Stellen Sie uns dafür eine technische Zeichnung im dxf bzw. dwg Format zur Verfügung.

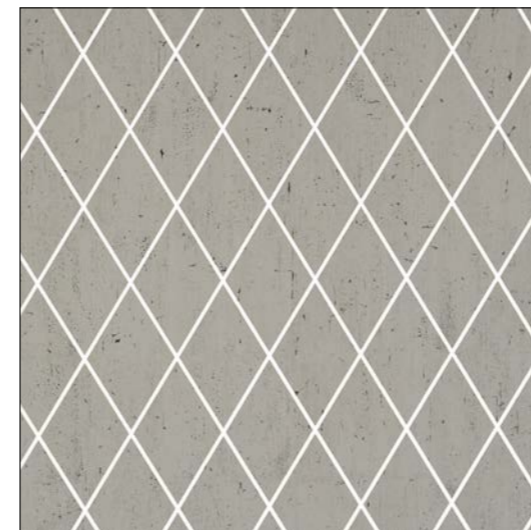

TL LINEA 104x62 OLD Platin

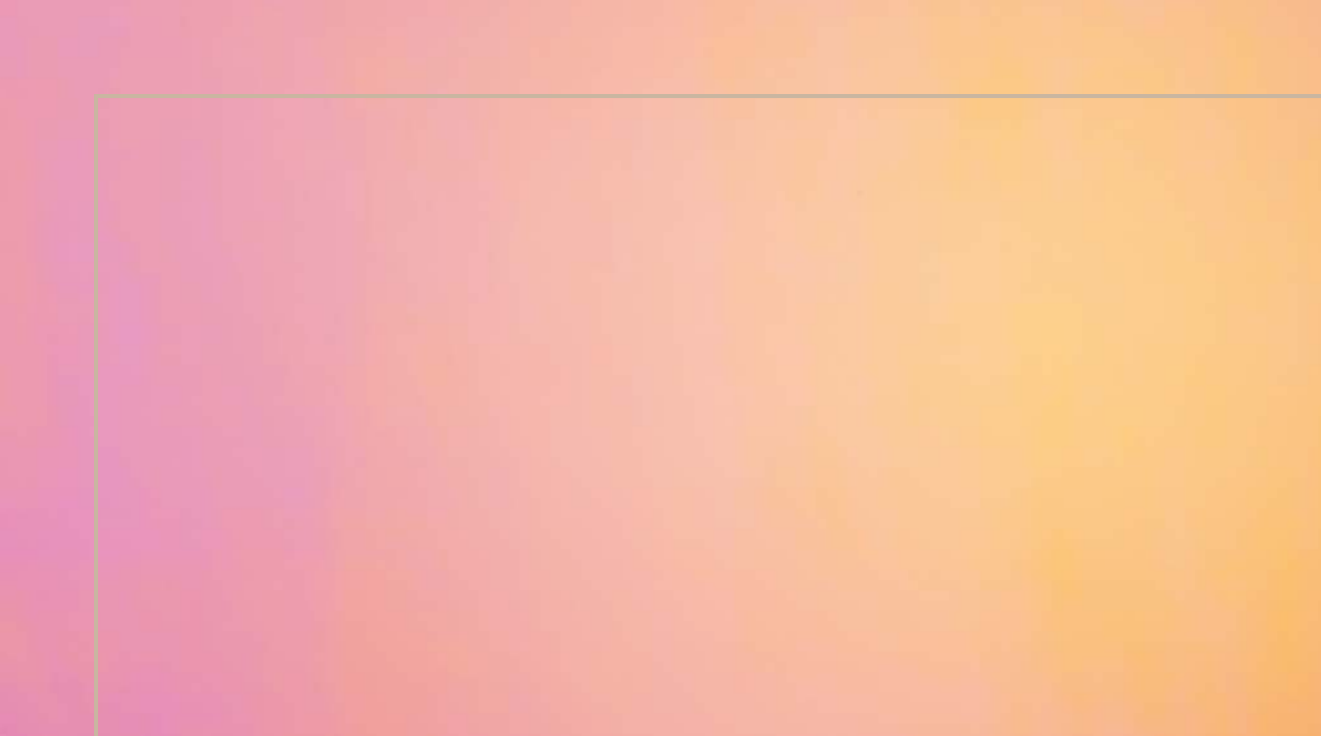



TRANS- LUCENT- LINE

Translucent designs for radiant accents and optical illusions.

The milled contours of the design panels can be backlit precisely, creating different moods and spatial experiences. The possibilities are limitless through milling options.

- › *In a wide variety of designs and contours*
- › *In a non-adhesive or self-adhesive version*

Lighting: LED, fluorescent tubes

INDIVIDUAL LIGHT MOTIFS POSSIBLE

Any logo, form or design can be created without any problems. Simply send us a technical drawing in dxf or dwg format.

WOOD-LINE

SIBU DESIGN goes Nature - mit der Produktlinie WOOD-LINE bieten wir Ihnen trendige Holzfarben mit lebendiger Holzstruktur. Die WOOD-LINE bringt einen Hauch Natur in jedes Zuhause.

Partiell oder auch großflächig angebracht, vollenden die Holzdekore von SIBU DESIGN Ihre Möbel. Lassen Sie Ihre Einrichtung durch die natürliche Haptik der WOOD-LINE neu aufleben.

Zu allen WOOD-LINE Produkten sind passende Kanten erhältlich.



WL Sessile OAK



WL OAK Tree Light



WOOD- LINE

SIBU DESIGN goes nature - our WOOD-LINE product range offers fashionable wood colours with vivid wooden structures. WOOD-LINE brings a breeze of nature into every home.

Whether used for small parts only or on a large scale, the wood patterns from SIBU DESIGN will lend your furniture the perfect finishing touch. So give new life to your furnishings with WOOD-LINE's natural haptics.

Matching edges are available for all WOOD-LINE products.



NATURE-LINE

Mit den selbstklebenden Produkten der NATURE-LINE werden nachhaltige Werkstoffe aus kontrollierter Herkunft mit modernem Design verbunden.

Durch das großzügige Produktformat können große Flächen schnell, einfach & schmutzfrei gestaltet werden. Das Ergebnis: homogene & fugenlose Wände, die nicht nur optisch ansprechen sondern auch die Umwelt schonen.

- › Großflächige dehnfugenfreie Gestaltungsmöglichkeiten
- › Extrem leicht, formstabil und kompakt - garantiert einfache Handhabung
- › Anpassung und Weiterverarbeitung mit handelsüblichen Schneidwerkzeugen
- › Die Produkte der NATURE-LINE sind FSC®-zertifiziert.

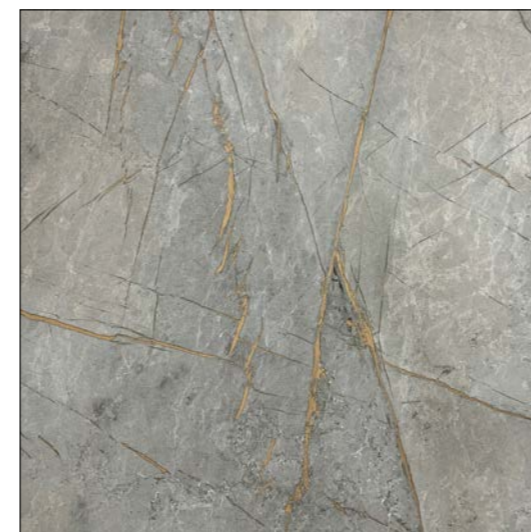

DM LIMESTONE Grey Nature SA



DM Corten Nature SA



NATURE-LINE

With the self-adhesive products of the NATURE-LINE, sustainable materials from controlled origin are combined with modern design.

Due to the generous product format, large surfaces can be designed quickly, easily & dirt-free. The result: homogeneous & seamless walls that are not only visually attractive but also environmentally friendly.

- › Extensive design options thanks to seamless bonding (no expansion gaps necessary)
- › Antigrav design panels are extremely light, dimensionally stable and compact, which guarantees easy handling
- › Customizing and further processing possible with standard cutting tools
- › The products of the NATURE-LINE are FSC®-certified.



The mark of responsible forestry
FSC® C172111



ANTIGRAV

DEHNFUGENFREIES VERARBEITEN

ANTIGRAV ist ein innovatives und leichtes Trägermaterial welches kombiniert mit SIBU DESIGN-Oberflächen als dehnfugenfreies Wandpanel eingesetzt werden kann.

- › Großflächige dehnfugenfreie Gestaltungsmöglichkeiten
- › Extrem leicht, formstabil und kompakt - garantiert einfache Handhabung
- › Anpassung und Weiterverarbeitung mit handelsüblichen Schneidwerkzeugen
- › Einfaches Nachjustieren durch Verklebung mit neutral freivernetztem Silikon oder MS Polymer-Hybridkleber auf allen Untergründen



DM CEMENT Light Antigrav

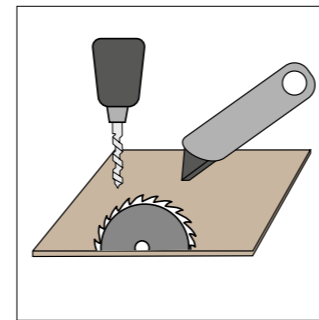

Die Bearbeitung erfolgt immer von der Dekoroberfläche.
Processing to be executed from the patterned side.

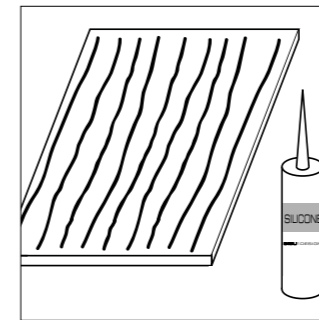

Silikonraupen vertikal auftragen
Apply beads of silicone vertically

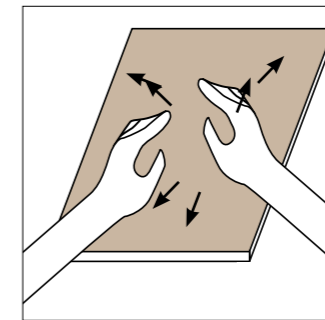

Platte auf der Wand fixieren und einrichten.
Press the sheet onto the wall and then adjust it.

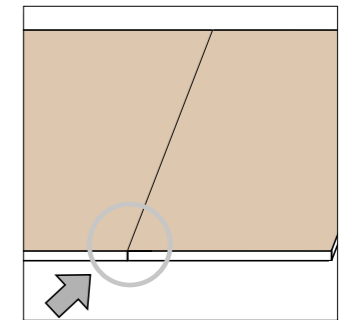

Stoß-an-Stoß-Verklebung = 0mm Dehnfuge
Seamless bonding = 0mm expansion joint



FL LAVA VELVET Volcano Antigrav

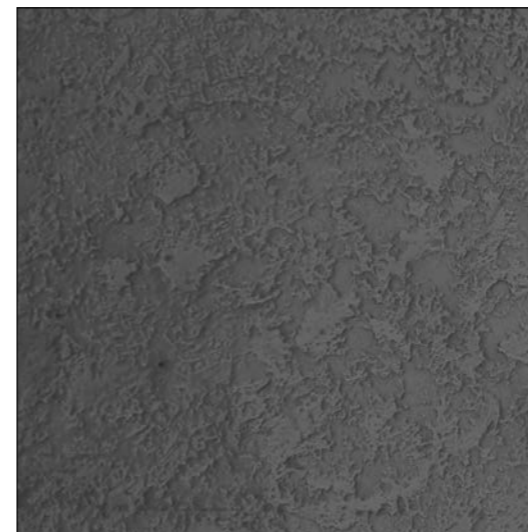

FL LAVA VELVET Volcano Antigrav

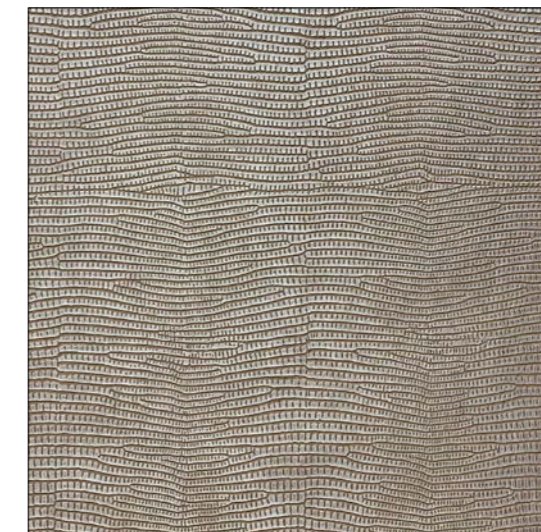

LL LEGUAN Silver Antigrav

ANTIGRAV

JOINT-FREE PROCESSING

ANTIGRAV is an innovative and light material which, combined with SIBU DESIGN surfaces, can be used as wall panel without expansion joints.

- › *Extensive design options thanks to seamless bonding (no expansion gaps necessary)*
- › *Antigrav design panels are extremely light, dimensionally stable and compact, which guarantees easy handling*
- › *Customizing and further processing possible with standard cutting tools*
- › *Easy readjustment on all surfaces by gluing with a neutral freely cross-linked silicone or MS polymer hybrid adhesive*



SIBU | COMB

INDIVIDUELLE WANDDESIGNS LEICHT GEMACHT!

Auf der Suche nach einem besonderen Eyecatcher als Alternative zu Wandfarbe und Tapete?

Dann ist SIBU | COMB die Lösung. Ansprechende Looks in angesagter Wabenform eröffnen neue Möglichkeiten für die individuelle Wandgestaltung. Und das komplett ohne Schmutz und Aufwand.

Die selbstklebenden SIBU | COMB Elemente können im Handumdrehen auf allen ebenen Untergründen montiert werden. Lassen Sie Ihrer Kreativität freien Lauf! Kombinieren Sie nach Lust und Laune und kreieren Sie Ihr individuelles Wanddesign.

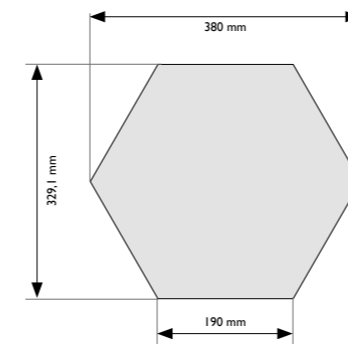

DM MARBLE White



WL Sessile OAK



SIBU | COMB

INDIVIDUAL WALL DESIGNS MADE EASY!

Are you looking for a special eye-catcher as an alternative to wall paint and wallpaper?

Then SIBU COMB is for you. Appealing looks in a trendy honeycomb shape open up new possibilities for individual wall design. And all of this without any dirt or effort.

The self-adhesive SIBU | COMB elements can be installed on all flat surfaces in no time. Let your creativity run free! Combine as you wish and create your own individual wall design.

BATH ART MATT

BATH ART MATT - raffiniert strukturiert, federleicht und antibakteriell. Die edle und schnelle Lösung für das gesamte Badezimmer. Erleben Sie SIBU DESIGN Produkte, die höchste Ansprüche an Design und Qualität vereinen, in matter Ausführung nun auch in der Duschkabine.

- › Langlebiger Einsatz durch abriebbeständige, matte Oberflächen mit „Antifingerprint“ Eigenschaften
- › Fugensparende und großflächige Anbringung (auch auf bestehende Fliesen) im Format 2600x1000 mm
- › Pflegeleicht und hygienisch: eine antibakterielle und antivirale Beschichtung sorgt für ein sorgenfreies Baderlebnis
- › Einfache Weiterverarbeitung direkt vor Ort mit herkömmlichen Holzbearbeitungs-Werkzeugen
- › Kostenersparnis durch die einfache, schmutzarme und vor allem schnelle Montage

□ BA TIMBER Jet Stream matt AR HPVC

□ BA TIMBER Sesame matt AR HPVC

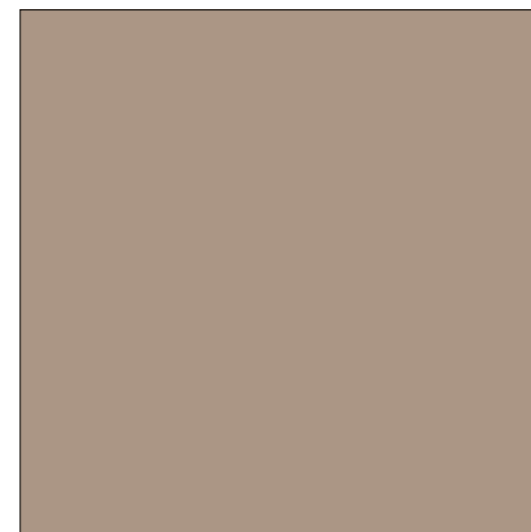

BA Sesame matt AR HPVC



BA RAW Dark Grey matt AR HPVC



BATH ART MATT

BATH ART MATT - subtly structured, light as a feather and antibacterial. The elegant and quick solution for the entire bathroom. Experience SIBU DESIGN products that combine the highest standards of design and quality in a matt finish now also in the shower cabin.

- › *Long-lasting use thanks to abrasion-resistant, matt surfaces with „anti-fingerprint“ properties*
- › *Joint-saving and large-area installation (also on existing tiles) in the format 2.600 x 1.000 mm*
- › *Easy to care for and hygienic: an antibacterial and antiviral coating ensures a trouble-free bathroom experience*
- › *Simple further processing directly on site with conventional woodworking tools*
- › *Cost savings thanks to the simple, dirt-free and, above all, quick assembly*

GASTRONOMIE HOTELLERIE

HOSPITALITY





Photo: Wisthaler.com

SCHIEBETÜREN *SLIDING DOORS*





MESSEDESIGN

EXHIBITION DESIGN





brunner

Hall 6, Booth F38
Hall 22, Booth C32

MÖBEL | KÜCHEN

FURNITURE | KITCHENS





WANDDEKORATION *WALL DECORATION*





LADENBAU

SHOP FITTING





Tony Evan

SCHAUFENSTER | DISPLAY

SHOPWINDOW | DISPLAY





WERBEMITTEL

ADVERTISING MATERIAL

Die SIBU DESIGN Verkaufsunterlagen auf einen Blick. *The range of SIBU DESIGN sales documentation at a glance.*



OVERVIEW

Gesamtkatalog *Complete catalogue*
Nur als PDF Version erhältlich! *PDF Version only*

SIBU World

Gesamtpräsentation
Overall presentation

SIBU Box

inkl. Muster des SIBU DESIGN-Lagerprogrammes
incl. samples from the SIBU DESIGN stock range

Produktkataloge *Product catalogs*

mit Originalmustern *with original samples*

- > About SIBU DESIGN
- > SIBUGLAS
- > DECO-LINE DISPLAY
- > DECO-LINE DECORATION
- > LEATHER-LINE
- > WOOD-LINE
- > MULTISTYLE
- > STRUCTURE-LINE
- > FABRIC-LINE
- > OPCA-LINE
- > NATURE-LINE
- > ANTIGRAV
- > BATH ART MATT
- > OPTICAL MIRROR



Tauchen auch Sie ein in die Welt von **SIBU DESIGN**.
Immerse yourself in the world of
SIBU DESIGN.

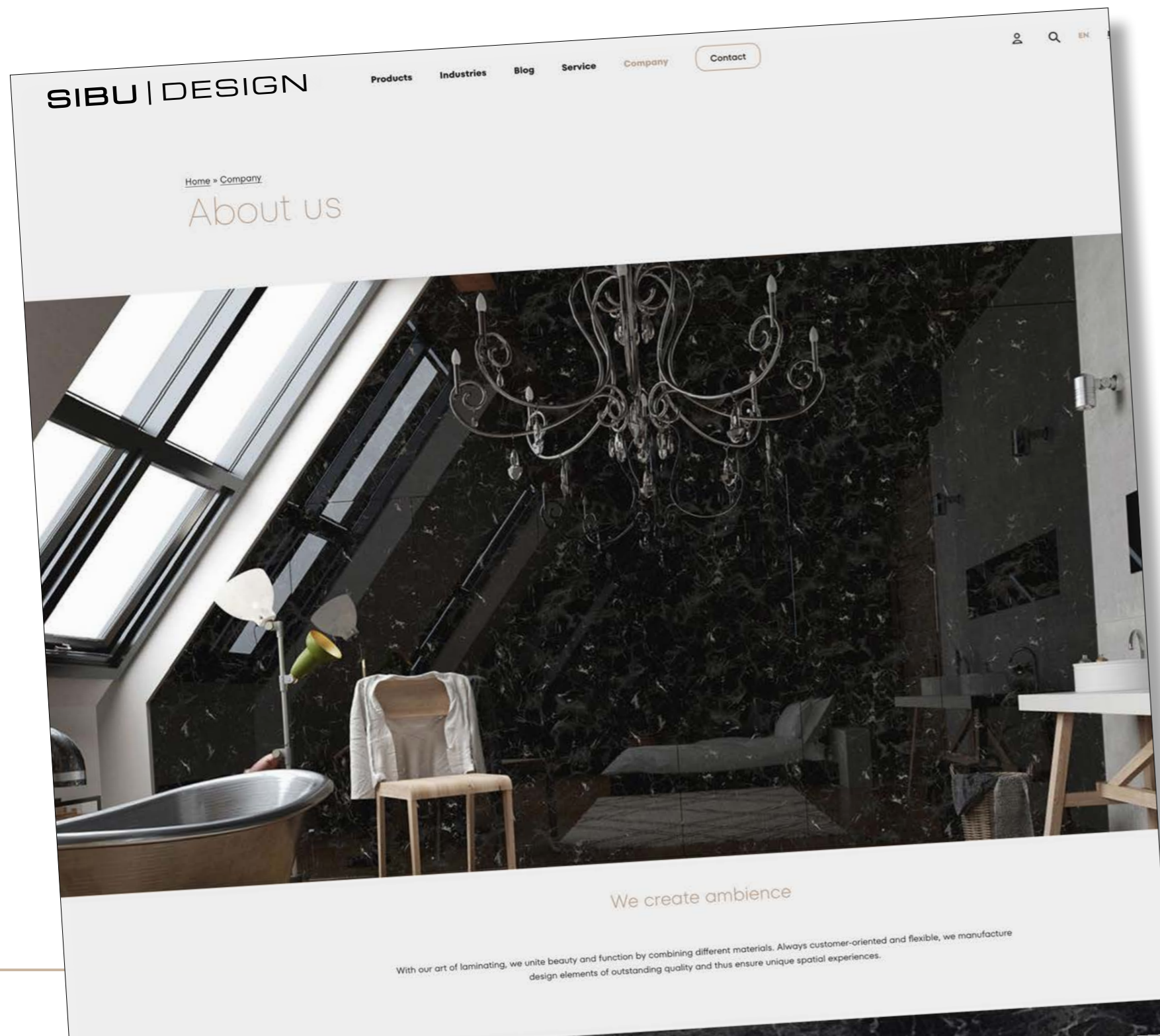

Detaillierte Informationen zu den Produkten finden Sie in unserem Katalog **OVERVIEW** oder auf der Website unter www.sibu.at.

*You can find more detailed information in our **SIBU OVERVIEW** and on our website at www.sibu.at.*

SIBU | DESIGN

SIBU DESIGN GmbH & Co KG

Jupiterstraße 8, 4452 Ternberg (Austria)

Tel: +43 (0) 7256.6025.0

info@sibu.at, www.sibu.at

