

The background of the entire page is a detailed, high-resolution image of marbled paper. The pattern is complex and organic, featuring swirling, vein-like structures in various shades of grey, taupe, and brown. The texture appears almost tactile, with some areas showing more pronounced ridges and valleys than others. The overall effect is one of natural, aged elegance.

# OVERVIEW

EN .v8

SIBU | DESIGN

**NA**

non-adhesive

**SA**

self-adhesive

**FR**

flame-retardant version  
available on request

**PRD**

digital printing possible

**PRS**

screen printing possible

**PR+**

digital/screen printing possible

**PR+\***

digital/screen printing possible  
Prior to printing a corona or plasma  
treatment has to be carried out.  
By request available in pre-treated version.

**PRS\***

screen printing possible  
Prior to printing a corona or plasma  
treatment has to be carried out.  
By request available in pre-treated version.

**■ ■ ■ ■**

wet room suitability

**■ ■ ■ □**

limited suitability for wet rooms

**AR**

abrasion-resistant

**AR+**

scratch-resistant

**+ ▽**

entire panel length not shown  
in image

**Continuous pattern**

Continuous pattern

**LEATHER-LINE (LL) 15**  
**FABRIC-LINE (FL) 35**  
**OPACO-LINE (OL) 43**  
**SIBUGLAS (SG) 49**  
**WOOD-LINE (WL) 67**  
**DECO-LINE (DM) 77**  
**MULTISTYLE (MS) 115**  
**STRUCTURE-LINE (SL) 123**  
**ACRYLIC-LINE (AC) 133**  
**TRANSLUCENT-LINE (TL) 137**  
**PUNCH-LINE / 3D (PL/PL3D) 141**  
**ANTIGRAV 149**

**LEGENDE 169**

PRODUCT CHARACTERISTICS 170  
EXTRA EQUIPMENT 172  
PROCESSING 173  
ACCESSORIES 174

**STORAGE / TRANSPORT GENERAL 175**

**CLEANING / DISPOSAL GENERAL 175**

**PROCESSING INSTRUCTIONS GENERAL 178**

**PROCESSING INSTRUCTIONS SIBUGLAS / OPACO-LINE 180**

GLUED AND PRESSED ON ABSORBENT WOOD BASED SHEETS SIBUGLAS / OPACO-LINE 180

BONDED ONTO COATED WOOD BASED SHEETS INCLUDING EDGES AND MILLING 183

GLUED AND PRESSED ON ABSORBENT WOOD BASED SHEETS 183

**PROCESSING INSTRUCTIONS ANTIGRAV 186**

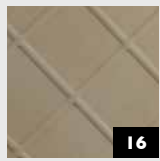
**SIBU | DESIGN**

**We create ambience.**

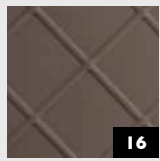
With our art of laminating, we unite beauty and function by combining different materials. Always customer-oriented and flexible, we manufacture design elements of outstanding quality and thus ensure unique spatial experiences.



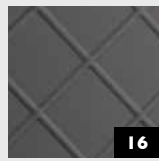
# LEATHER-LINE



LL CORD  
Stony Ground



LL CORD  
Dove Tale



LL CORD  
Charcoal Light



LL ROMBO 40  
Bianco matt



LL ROMBO 40  
Creme matt



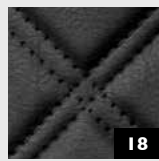
LL ROMBO 40  
Nero matt



LL ROMBO 85  
Bianco matt



LL ROMBO 85  
Creme matt



LL ROMBO 85  
Nero matt



LL CRISTAL  
ROMBO 85 Bianco  
matt/Silver



LL QUADRO  
Bianco matt



LL QUADRO  
Creme matt



LL QUADRO  
Nero matt



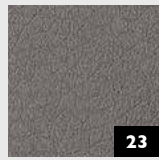
LL QUADRO  
LUXURY Bronze



LL COLLAGE  
Oro



LL Charcoal  
Dark



LL Charcoal  
Light



LL Dove Tale



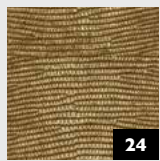
LL London Clay



LL Stony Ground



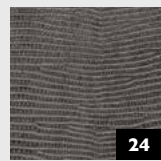
LL LEGUAN  
Silver



LL LEGUAN  
Gold



LL LEGUAN  
Copper



LL LEGUAN  
Nero



LL LEGUAN  
Bianco



LL PERSIAN  
Gold



LL PERSIAN  
Metallic



LL PEARL RAY  
Gold



LL FLORAL  
White



LL FLORAL  
VINTAGE Silver/  
Silver



LL FLORAL  
White/Silver  
matt



LL FLORAL  
White/Gold matt



LL FLORAL  
Black/Silver matt



LL CURVED  
Silver



LL CURVED  
Gold



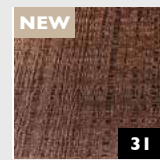
LL CURVED  
Rose



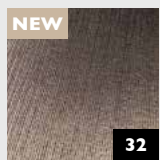
LL GRID Silver



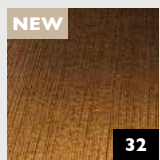
LL GRID Gold



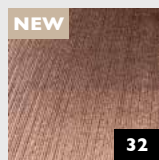
LL GRID Rose



LL ALIGNED  
Silver



LL ALIGNED  
Gold



LL ALIGNED  
Rose



## FABRIC-LINE



FL CUBE VELVET  
Bordeaux



FL CUBE VELVET  
Pearl



FL CREPA  
VELVET Avocado



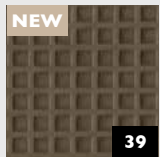
FL CREPA  
VELVET Volcano



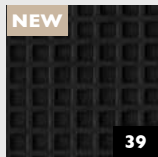
FL COMB  
VELVET Curry



FL COMB  
VELVET Pearl



FL SQUARE 2  
VELVET Mocha



FL SQUARE 2  
VELVET Coal

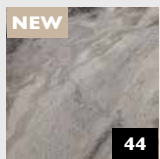


FL LAVA VELVET  
Coal



FL LAVA VELVET  
Volcano

## OPACO-LINE



OL MARBLE  
Alpine matt AR



OL GENESIS  
White matt AR



OL MARBLE  
White matt AR



OL MARBLE  
Black matt AR

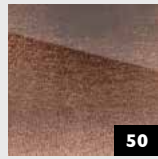
# SIBUGLAS



SG CURVED  
Silver AR+



SG CURVED  
Gold AR+



SG CURVED  
Rose AR+



SG ALIGNED  
Silver AR+



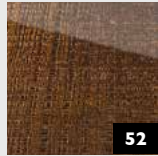
SG ALIGNED  
Gold AR+



SG ALIGNED  
Rose AR+



SG GRID  
Silver AR+



SG GRID  
Gold AR+



SG GRID  
Rose AR+



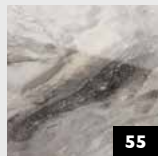
SG GENESIS  
Grey AR+



SG GENESIS  
White AR+



SG MARBLE  
Brown AR+



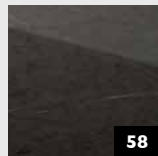
SG MARBLE  
Alpine AR+



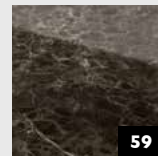
SG MARBLE  
Black AR+



SG MARBLE  
White AR+



SG MARBLE  
Grey AR+



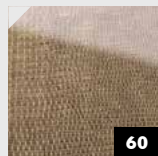
SG MARBLE  
Emperador AR+



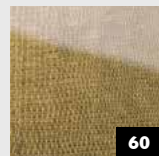
SG LEGUAN  
Bianco met AR+



SG LEGUAN  
Silver AR+



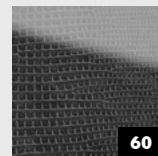
SG LEGUAN Silk  
AR+



SG LEGUAN  
Gold AR+



SG LEGUAN  
Copper AR+



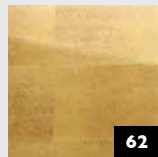
SG LEGUAN  
Nero AR+



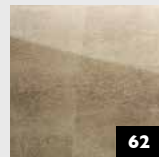
SG VINTAGE  
Silver AR+



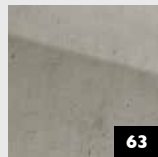
SG VINTAGE  
Copper AR+



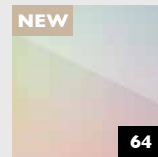
SG LUXURY  
Gold AR+



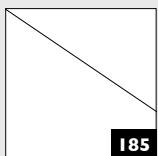
SG LUXURY  
Bronze AR+



SG OLD Platin  
AR+



SG HOLLYWOOD

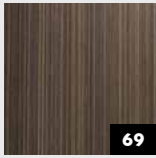


suitable  
balancing sheet

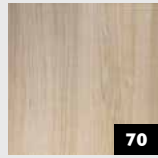
## WOOD-LINE



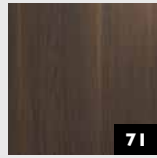
WL Carbonized  
Wood



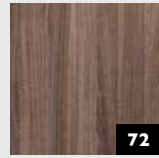
WL Wenge  
Wood



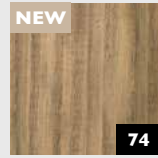
WL Maple Alpine



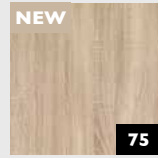
WL Nutwood



WL Nutwood  
Country



WL Sessile OAK



WL OAK TREE  
Light



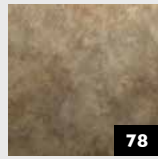
# DECO-LINE



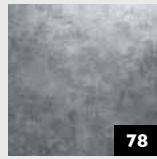
DM OXIDIZED  
Autumn AR



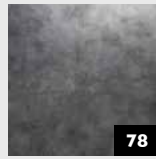
DM OXIDIZED  
Copper AR



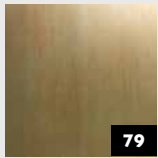
DM OXIDIZED  
Nickel AR



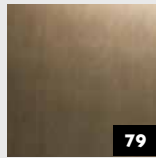
DM OXIDIZED  
Platin AR



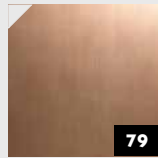
DM OXIDIZED  
Titan AR



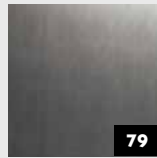
DM SLIGHTLY  
USED Gold AR



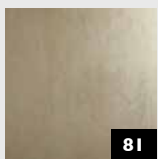
DM SLIGHTLY  
USED Bronze AR



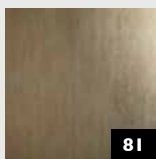
DM SLIGHTLY  
USED Copper AR



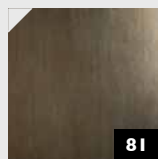
DM SLIGHTLY  
USED Titan AR



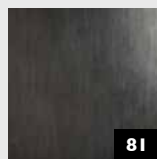
DM METALLIC  
USED Ivory AR



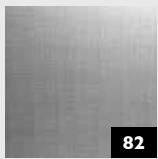
DM METALLIC  
USED Sand AR



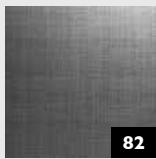
DM METALLIC  
USED Bronze AR



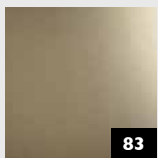
DM METALLIC  
USED Steel AR



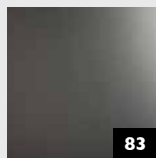
DM REFINED  
METAL Silver AR



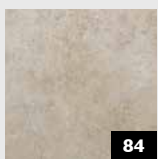
DM REFINED  
METAL Titan AR



DM METALLIC  
USED  
Champagne AR



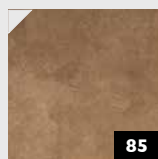
DM METALLIC  
USED Titan AR



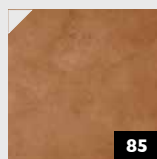
DM Iron Age AR



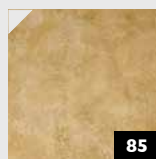
DM CLASSY  
Silver AR



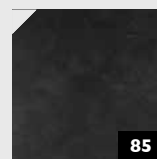
DM CLASSY  
Bronze AR



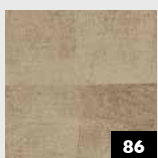
DM CLASSY  
Copper AR



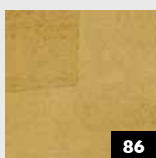
DM CLASSY Gold  
AR



DM CLASSY  
Black AR



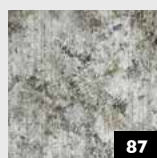
DM LUXURY  
Bronze AR



DM LUXURY  
Gold AR

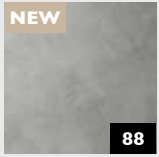


DM VINTAGE  
Copper



DM VINTAGE  
Silver

# DECO-LINE



DM CONCRETE  
Grey



DM MONSOON  
VINTAGE Brown



DM CEMENT  
Light



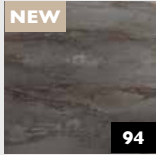
DM CEMENT  
Dark



DM MARBLE  
White



DM Travertin



DM GENESIS  
Grey supermatt  
AR



DM GENESIS  
White supermatt  
AR



DM MARBLE  
White supermatt  
AR



DM MARBLE  
Black supermatt  
AR



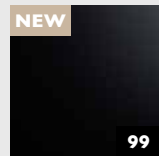
DM MAGIC  
White AR



DM MAGIC  
Black AR



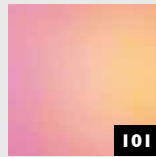
DM Snow White  
matt AR



DM Graphite  
Black matt AR



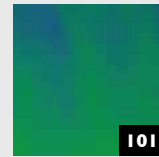
DM GALAXY  
Silver



DM Hollywood



DM Hollywood  
Blue



DM Aqua



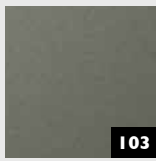
DM LUXURY  
Holografico

# DECO-LINE



103

DM Silver PF



103

DM Smoke PF



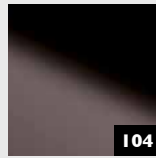
104

DM OPTICAL MIRROR Silver AR



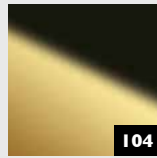
104

DM OPTICAL MIRROR Fashion Grey AR



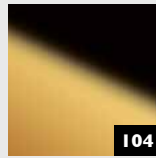
104

DM OPTICAL MIRROR Anthracite AR



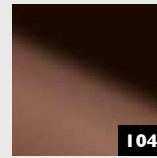
104

DM OPTICAL MIRROR Brass AR



104

DM OPTICAL MIRROR Gold AR



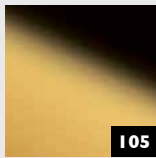
104

DM OPTICAL MIRROR Copper AR



105

DM Silver MMS



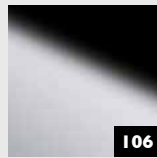
105

DM Gold MMS



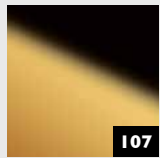
106

DM Silver



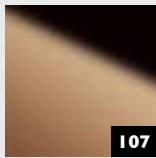
106

DM Silver/White



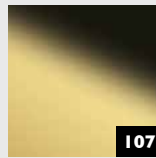
107

DM Gold AR



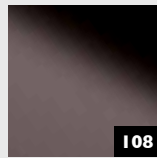
107

DM Rosegold AR



107

DM Brass AR



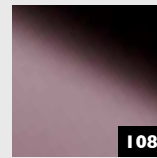
108

DM Anthracite AR



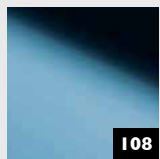
108

DM Brown AR



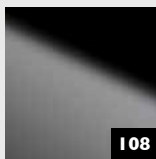
108

DM Rose AR



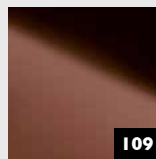
108

DM Iceblue AR



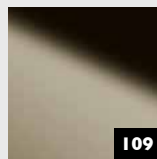
108

DM Fashion Grey AR



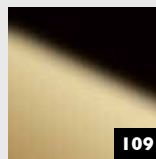
109

DM Bronze



109

DM Champagne



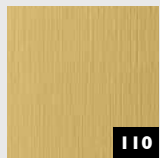
109

DM Gold 30



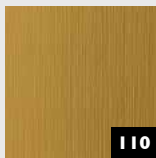
109

DM Fashion Red



110

DM Brass brushed matt AR



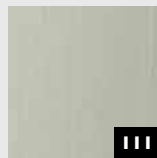
110

DM Gold brushed matt AR



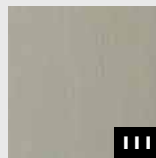
111

DM Silver brushed



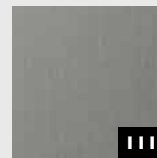
111

DM HGS



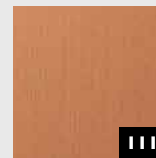
111

DM Champagne brushed



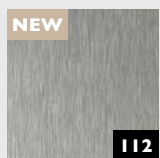
111

DM Titan brushed



111

DM Copper brushed



NEW

112

DM DEEP BRUSHED Gravel



NEW

112

DM DEEP BRUSHED Sandy



## MULTISTYLE



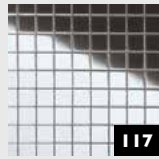
MS 3x3 flex  
Classic Silver



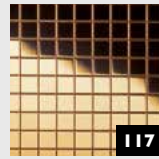
MS 3x3 flex  
Classic Gold AR



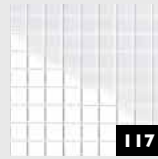
MS 5x5 flex  
Classic Hollywood



MS 5x5 flex  
Classic Silver



MS 5x5 flex  
Classic Gold AR



MS 5x5 flex  
Classic MAGIC  
White



MS 5x5 flex  
Classic GALAXY  
Silver



MSC 10x10 flex  
Classic Silver



MSC 30x30 flex  
Classic Silver



MS 10x10 flex  
Classic Silver



MS 10x10 flex  
Classic Gold AR



MS 20x20 flex  
Classic Silver

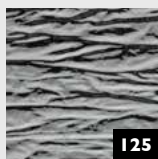


MS 20x20 flex  
Classic Gold AR

## STRUCTURE-LINE



SL CRASHED  
OLD Platin



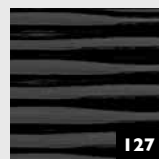
SL CRASHED  
Silver



SL IMPACT  
VINTAGE Silver



SL IMPACT  
ANTIQUE Bronze



SL MOTION  
TWO MAGIC  
Black AR



SL LAVA VINTAGE  
Copper



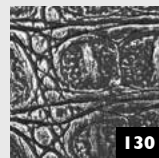
SL RACE  
VINTAGE Silver/  
Bronze



SL RACE  
VINTAGE Copper/  
Silver



SL CROCO  
Silver PF/Silver



SL CROCO  
Smoke PF/Silver



SL SQUARE 3  
HGS

# ACRYLIC-LINE



134

AC MOTION  
ONE White



135

AC MOTION  
TWO White

# TRANSLUCENT-LINE



138

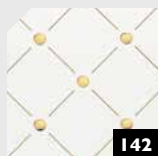
TL LINEA  
104x62 OLD  
Platin

# PUNCH-LINE / 3D



142

PL3D Q-10-30  
OLD Platin/Silver



142

PL3D H-10-30  
Pearl White  
PF/Gold



144

PL3D ROSES  
Pearl White PF/  
Gold



144

PL3D ROSES  
Silver PF/Silver



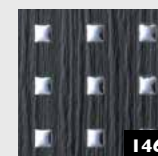
145

PL3D Q 10-40-40  
Silver PF/Silver



145

PL3D Q 10-40-40  
Smoke PF T1/  
Silver matt



146

PL3D Q 5-15-15  
Black T1/Silver



147

PL Q 5-15-15  
Silver PF

# ANTIGRAV



FL CREPA  
VELVET Avocado  
Antigrav



FL CREPA  
VELVET Volcano  
Antigrav



FL LAVA  
VELVET Coal  
Antigrav



FL LAVA  
VELVET Volcano  
Antigrav



FL COMB  
VELVET Curry  
Antigrav



FL COMB  
VELVET Pearl  
Antigrav



FL SQUARE 2  
VELVET Mocha  
Antigrav



FL SQUARE 2  
VELVET Coal  
Antigrav



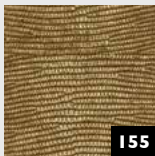
FL CUBE VELVET  
Bordeaux  
Antigrav



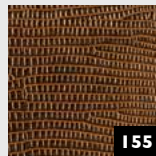
FL CUBE  
VELVET Pearl  
Antigrav



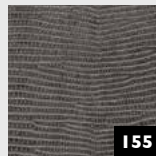
LL LEGUAN  
Silver



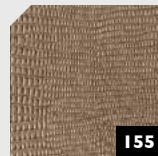
LL LEGUAN  
Gold



LL LEGUAN  
Copper



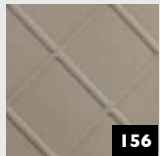
LL LEGUAN  
Nero



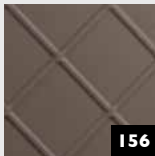
LL LEGUAN Silk



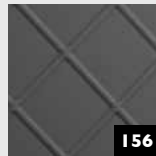
LL LEGUAN  
Bianco



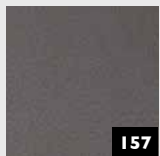
LL CORD  
Stony Ground  
Antigrav



LL CORD  
Dove Tale  
Antigrav



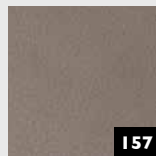
LL CORD  
Charcoal Light  
Antigrav



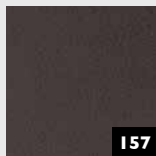
LL Charcoal  
Dark Antigrav



LL Charcoal  
Light Antigrav



LL Dove Tale  
Antigrav



LL London Clay  
Antigrav



LL Stony Ground  
Antigrav



DM CEMENT  
Dark Antigrav



DM CEMENT  
Light Antigrav



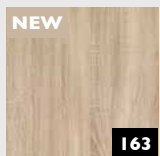
DM Travertin  
Antigrav



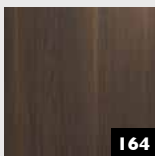
DM MARBLE  
White Antigrav



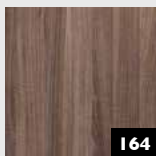
DM CONCRETE  
Grey Antigrav



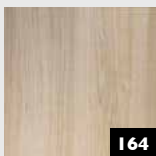
WL OAK TREE  
Light Antigrav



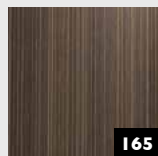
WL Nutwood  
Antigrav



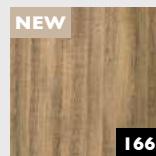
WL Nutwood  
Country Antigrav



WL Maple Alpine  
Antigrav



WL Wenge Wood  
Antigrav



WL Sessile OAK  
Antigrav



WL Carbonized  
Wood Antigrav





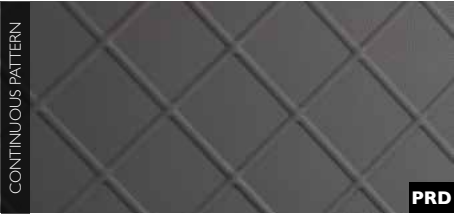
# LEATHER- LINE



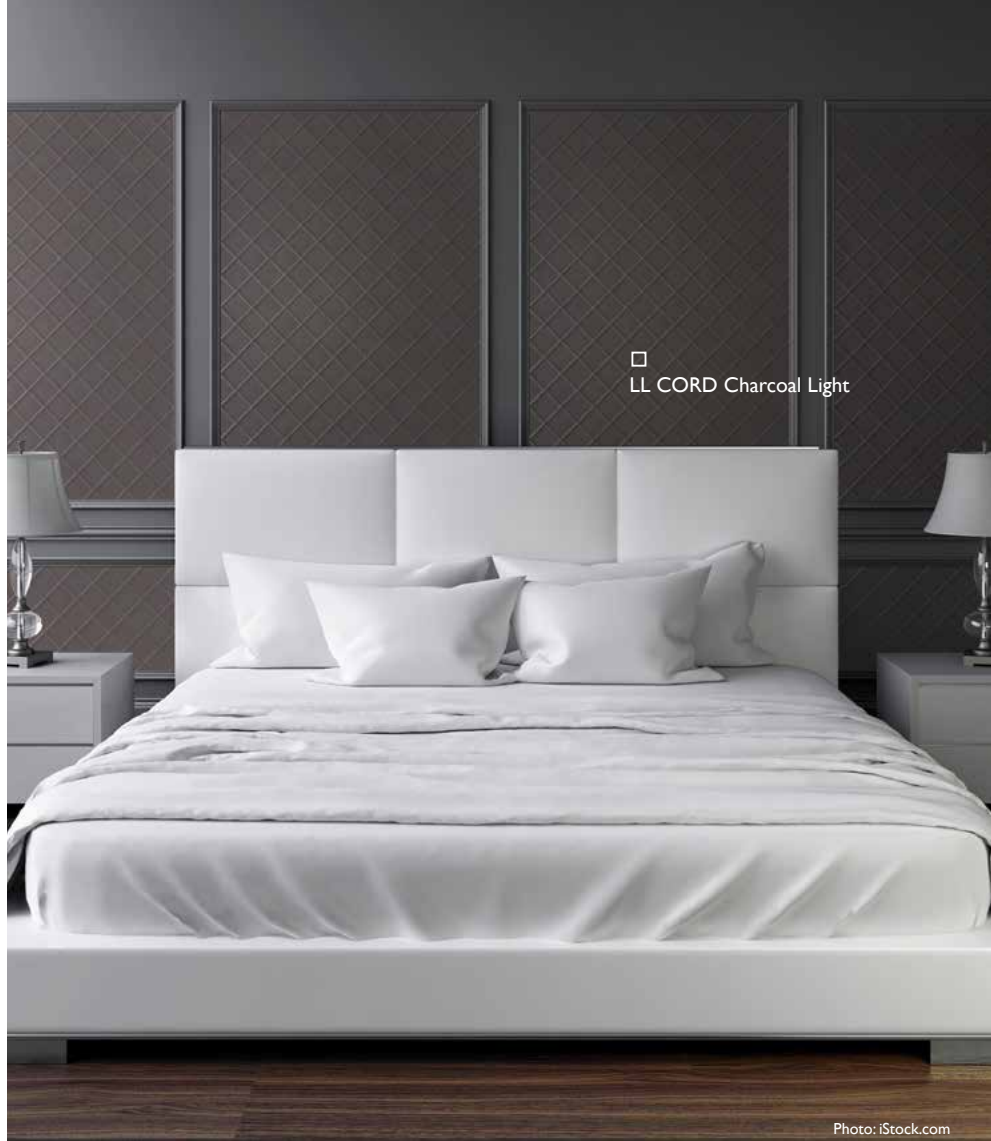
**LL CORD Stony Ground**  
2600 x 1000 / **NA** 19542 / **SA** 19545



**LL CORD Dove Tale**  
2600 x 1000 / **NA** 19532 / **SA** 19544



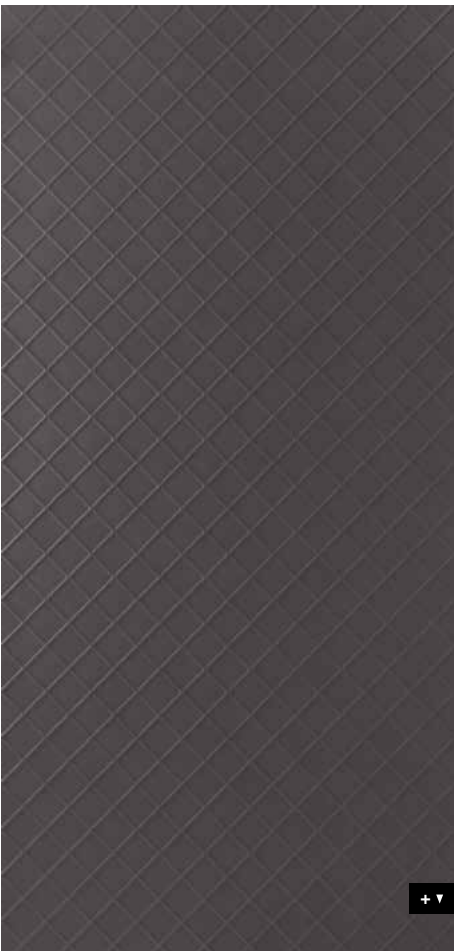
**LL CORD Charcoal Light**  
2600 x 1000 / **NA** 19543 / **SA** 19546



□ LL CORD Charcoal Light

Photo: iStock.com

2600 x 1000



## LEATHER-LINE

# LL CORD

### Product characteristics

	NA	SA
Base material	HIPS	
Surface material	PU-leather	
Material thickness mm	2	2,13
Max. relief height mm	3,2	3,33
Temperature stability	up to 60 °C	
Wet room suitability	■■■■■	
Rolled packable *	✓	✓
Wight/Designsheet ~	3,4 kg	3,8 kg

\* Design sheets to be rolled with the decor side outwardly (both – NA and SA version). We recommend rolling not more than 3 sheets per carton (480 x 480 mm).

### Extra equipment

	NA	SA
Special formats	–	–
Further thicknesses	–	–
Cuttings	✓	✓
Magnetic from 3 sheets	✓	
PVA pre-treatment	✓	–

### Processing

	NA	SA
Cutting, punching	✓	✓
Drilling	✓	✓
Sawing	✓	–
Milling	–	–
Laser cutting	✓	✓
Hot bending	✓	–
PVA compressible	✓	–
Smallest bending radius	150 mm	150 mm

### Accessories

SIBUKLE	Spatula A2
---------	------------

### Special colors

On request
------------

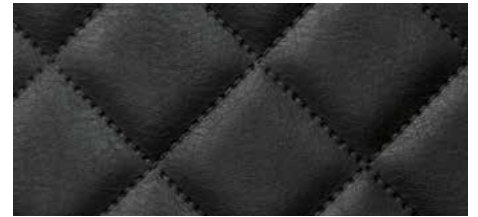




**LL ROMBO 40 Bianco matt**  
2600 x 1000 / **NA** I5025 / **SA** I5041



**LL ROMBO 40 Creme matt**  
2600 x 1000 / **NA** I3848 / **SA** I3863



**LL ROMBO 40 Nero matt**  
2600 x 1000 / **NA** I5014 / **SA** I5029



## LEATHER-LINE

# LL ROMBO 40

2600 x 1000



### Product characteristics

	NA	SA
Base material	HIPS, PE-foam	
Surface material	PU-leather	
Material thickness mm	3,8	4,04
Max. relief height mm	5,0	5,24
Temperature stability	up to 60 °C	
Wet room suitability	■■■■■	
Rolled packable *	✓	✓

\* Design sheets to be rolled with the decor side outwardly (both – NA and SA version). We recommend rolling not more than 3 sheets per carton (480 x 480 mm).

### Processing

	NA	SA
Cutting, punching	✓	✓
Drilling	✓	✓
Sawing, milling	–	–
Laser cutting	✓	✓
Hot bending	–	–
PVA compressible	–	–
Smallest bending radius	300 mm	300 mm

### Extra equipment

	NA	SA
Special formats	–	–
Further thicknesses	–	–
Cuttings	✓	✓
Magnetic	–	
PVA pre-treatment	–	–

### Accessories

SIBUKLE	Spatula A2
---------	------------

### Special colors

On request
------------

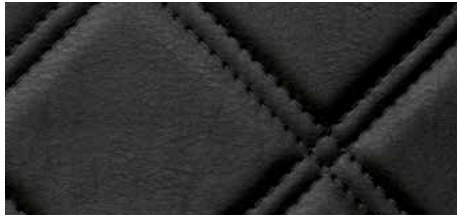




**LL ROMBO 85 Bianco matt**  
2600 x 1000 / **NA** I5026 / **SA** I5042



**LL ROMBO 85 Creme matt**  
2600 x 1000 / **NA** I3852 / **SA** I3867



**LL ROMBO 85 Nero matt**  
2600 x 1000 / **NA** I5015 / **SA** I5030



□  
LL ROMBO 85  
Creme matt

Photo: Boris Breuer - CABINET Schranksysteme AG

2600 x 1000



## LEATHER-LINE

# LL ROMBO 85

### Product characteristics

	NA	SA
Base material	HIPS, PE-foam	
Surface material	PU-leather	
Material thickness mm	3,8	4,04
Max. relief height mm	5,0	5,24
Temperature stability	up to 60 °C	
Wet room suitability	■■■■■	
Rolled packable *	✓	✓

\* Design sheets to be rolled with the decor side outwardly (both – NA and SA version). We recommend rolling not more than 3 sheets per carton (480 x 480 mm).

### Extra equipment

	NA	SA
Special formats	–	–
Further thicknesses	–	–
Cuttings	✓	✓
Magnetic	–	
PVA pre-treatment	–	–

### Processing

	NA	SA
Cutting, punching	✓	✓
Drilling	✓	✓
Sawing, milling	–	–
Laser cutting	✓	✓
Hot bending	–	–
PVA compressible	–	–
Smallest bending radius	300 mm	300 mm

### Accessories

SIBUKLE	Spatula A2
---------	------------

### Special colors

On request
------------



□  
LL CRISTAL ROMBO 85  
Bianco matt/Silver



**LL CRISTAL ROMBO 85 Bianco matt/Silver**  
2600 x 1000 / SA 15044

Photo: Cary Horowitz

## LEATHER-LINE

# LL CRISTAL ROMBO 85

2600 x 1000

### Product characteristics

	SA
Base material	HIPS, PE-foam
Surface material	PU-leather, crystal: PMMA
Material thickness mm	4,04
Max. relief height mm	5,24
Temperature stability	up to 60 °C
Wet room suitability	■■■□
Rolled packable *	✓

\* Design sheets to be rolled with the decor side outwardly (both – NA and SA version). We recommend rolling not more than 3 sheets per carton (480 x 480 mm).

### Processing

	SA
Cutting, punching	✓
Drilling	✓
Sawing, milling	—
Laser cutting	✓
Hot bending	—
PVA compressible	—
Smallest bending radius	300 mm

### Extra equipment

	SA
Special formats	—
Further thicknesses	—
Cuttings	✓
Magnetic	—
PVA pre-treatment	—

### Accessories

SIBUKLE	Spatula A2
---------	------------

### Special colors

On request
------------







**LL QUADRO Bianco matt**  
2600 x 1000 / **NA** I4270 / **SA** I5175



**LL QUADRO Creme matt**  
2600 x 1000 / **NA** I4273 / **SA** I4277



**LL QUADRO Nero matt**  
2600 x 1000 / **NA** I5017 / **SA** I5032



□ LL QUADRO Nero matt

Photo: Jesse



□ LL QUADRO Creme matt

Photo: Bertrand Benoit

2600 x 1000



## LEATHER-LINE

# LL QUADRO

### Product characteristics

	NA	SA
Base material	HIPS, PE-foam	
Surface material	PU-leather	
Material thickness mm	2,8	3,04
Max. relief height mm	4,8	5,04
Temperature stability	up to 60 °C	
Wet room suitability	■■■■■	
Rolled packable *	✓	✓

\* Design sheets to be rolled with the decor side outwardly (both – NA and SA version). We recommend rolling not more than 3 sheets per carton (480 x 480 mm).

### Extra equipment

	NA	SA
Special formats	–	–
Further thicknesses	–	–
Cuttings	✓	✓
Magnetic	–	
PVA pre-treatment	–	–

### Processing

	NA	SA
Cutting, punching	✓	✓
Drilling	✓	✓
Sawing, milling	–	–
Laser cutting	✓	✓
Hot bending	–	–
PVA compressible	–	–
Smallest bending radius	300 mm	300 mm

### Accessories

SIBUKLE	Spatula A2
---------	------------

### Special colors

On request
------------



**LL QUADRO LUXURY Bronze**  
2600 x 1000 / **NA** 17831 / **SA** 17851

□  
LL QUADRO  
LUXURY Bronze

## LEATHER-LINE

# LL QUADRO

### Product characteristics

	NA	SA
Base material	HIPS, PE-foam	
Surface material	PU-leather	
Material thickness mm	2,8	3,04
Max. relief height mm	4,8	5,04
Temperature stability	up to 60 °C	
Wet room suitability	■■■■□	
Rolled packable *	✓	✓

\* Design sheets to be rolled with the decor side outwardly (both – NA and SA version). We recommend rolling not more than 3 sheets per carton (480 x 480 mm).

### Extra equipment

	NA	SA
Special formats	–	–
Further thicknesses	–	–
Cuttings	✓	✓
Magnetic	–	
PVA pre-treatment	–	–

### Processing

	NA	SA
Cutting, punching	✓	✓
Drilling	✓	✓
Sawing, milling	–	–
Laser cutting	✓	✓
Hot bending	–	–
PVA compressible	–	–
Smallest bending radius	300 mm	300 mm

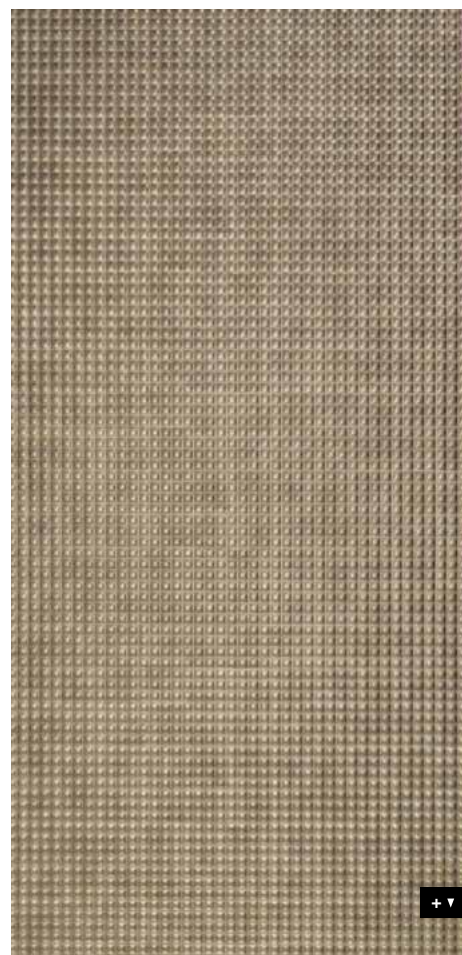
### Accessories

SIBUKLE	Spatula A2
---------	------------

### Special colors

On request
------------

2600 x 1000







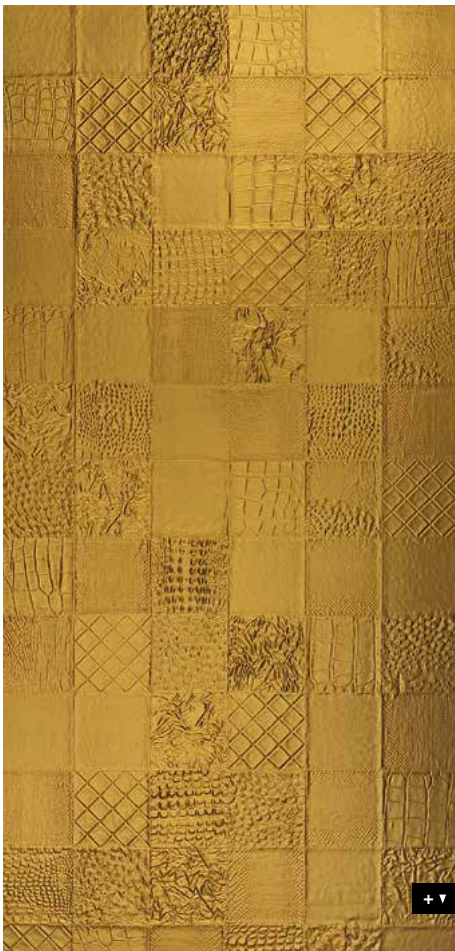
### LL COLLAGE Oro

2600 x 1000 / 1,9 / NA 13923 / SA 13926



□  
LL COLLAGE Oro

2600 x 1000



## LEATHER-LINE

# LL COLLAGE

### Product characteristics

	NA	SA
Base material	HIPS	
Surface material	PU-leather	
Material thickness mm	1,9	2,15
Max. relief height mm	3,5	3,75
Temperature stability	up to 60 °C	
Wet room suitability	■ ■ ■ □	
Rolled packable *	✓	✓

\* Design sheets to be rolled with the decor side outwardly (both – NA and SA version). We recommend rolling not more than 3 sheets per carton (480 x 480 mm).

### Processing

	NA	SA
Cutting, punching	✓	✓
Drilling	✓	✓
Sawing	✓	—
Milling	—	—
Laser cutting	✓	✓
Hot bending	✓	—
PVA compressible	✓	—
Smallest bending radius	150 mm	150 mm

### Extra equipment

	NA	SA
Special formats	—	—
Further thicknesses	—	—
Cuttings	✓	✓
Magnetic from 3 sheets	✓	
PVA pre-treatment Oro	—	—

### Accessories

SIBUKLE	Spatula A2
---------	------------

### Special colors

On request
------------



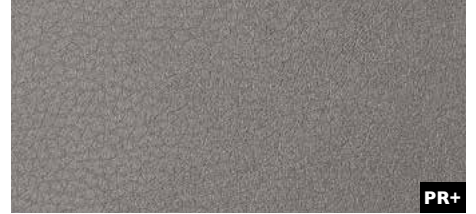


□ LL Dove Tale

Photo: © istock.com



**LL Charcoal Dark**  
2600 x 1000 / **NA** 19299 / **SA** 19302



**LL Charcoal Light**  
2600 x 1000 / **NA** 19298 / **SA** 19301



**LL Dove Tale**  
2600 x 1000 / **NA** 19013 / **SA** 19024



**LL London Clay**  
2600 x 1000 / **NA** 19014 / **SA** 19025



**LL Stony Ground**  
2600 x 1000 / **NA** 19012 / **SA** 19023

## LEATHER-LINE

# LEATHER-LINE

### Product characteristics

	NA	SA
Base material	HIPS	
Surface material	PU-leather	
Material thickness mm	1,95	2,08
Temperature stability	up to 60 °C	
Wet room suitability	■■■■	
Rolled packable *	✓	✓

\* Design sheets to be rolled with the decor side outwardly (both – NA and SA version). We recommend rolling not more than 3 sheets per carton (480 x 480 mm).

### Processing

	NA	SA
Cutting, punching	✓	✓
Drilling	✓	✓
Sawing	✓	—
Milling	—	—
Laser cutting	✓	✓
Hot bending	✓	—
PVA compressible	✓	—
Smallest bending radius	150 mm	150 mm

### Extra equipment

	NA	SA
Special formats	On request	
Further thicknesses	✓	✓
Cuttings	✓	✓
Magnetic from 3 sheets	✓	
PVA pre-treatment	✓	—

### Accessories

SIBUKLE	Spatula A1
---------	------------

### Special colors

On request
------------



**LL LEGUAN Silver**

2600 x 1000 / **NA** 12883 / **SA** 12893



**LL LEGUAN Gold**

2600 x 1000 / **NA** 13480 / **SA** 13478



**LL LEGUAN Copper**

2600 x 1000 / **NA** 12884 / **SA** 12894



**LL LEGUAN Nero**

2600 x 1000 / **NA** 14778 / **SA** 14797

2600 x 1000



□ LL LEGUAN Silver

LEATHER-LINE

LL LEGUAN

**Product characteristics**

	NA	SA
Base material	HIPS	
Surface material	PU-leather	
Material thickness mm	1,5	1,63
Temperature stability	up to 60 °C	
Wet room suitability	■■■□	
Rolled packable *	✓	✓

\* Design sheets to be rolled with the decor side outwardly (both – NA and SA version). We recommend rolling not more than 3 sheets per carton (480 x 480 mm).

**Processing**

	NA	SA
Cutting, punching	✓	✓
Drilling	✓	✓
Sawing	✓	–
Milling	–	–
Laser cutting	✓	✓
Hot bending	✓	–
PVA compressible	✓	–
Smallest bending radius	150 mm	150 mm

**Extra equipment**

	NA	SA
Special formats	On request	
Further thicknesses	✓	✓
Cuttings	✓	✓
Magnetic from 3 sheets	✓	
PVA pre-treatment	✓	–

**Accessories**

SIBUKLE	Spatula A1
---------	------------

**Special colors**

–
---



**LL LEGUAN Bianco**  
2600 x 1000 / 1,4 mm / **NA** 15609 / **SA** 15610



## LEATHER-LINE

# LL LEGUAN

2600 x 1000

### Product characteristics

	NA	SA
Base material	HIPS	
Surface material	PU-leather	
Material thickness mm	1,4 / 1,5	1,53 / 1,63
Temperature stability	up to 60 °C	
Wet room suitability	■■■■■	
Rolled packable *	✓	✓

\* Design sheets to be rolled with the decor side outwardly (both – NA and SA version). We recommend rolling not more than 3 sheets per carton (480 x 480 mm).

### Processing

	NA	SA
Cutting, punching	✓	✓
Drilling	✓	✓
Sawing	✓	—
Milling	—	—
Laser cutting	✓	✓
Hot bending	✓	—
PVA compressible	✓	—
Smallest bending radius	150 mm	150 mm

### Extra equipment

	NA	SA
Special formats	On request	
Further thicknesses	✓	✓
Cuttings	✓	✓
Magnetic from 3 sheets	✓	
PVA pre-treatment	✓	—

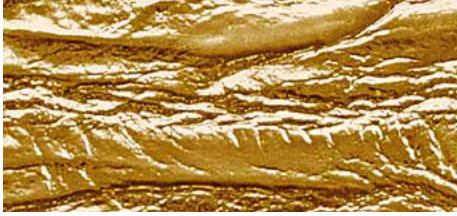
### Accessories

SIBUKLE	Spatula A I
---------	-------------

### Special colors

—
---





**LL PERSIAN Gold**

2600 x 1000 / **NA** I5656 / **SA** I5660



**LL PERSIAN Metallic**

2600 x 1000 / **NA** I5655 / **SA** I5659



□ LL PERSIAN Gold

2600 x 1000



LEATHER-LINE

**LL PERSIAN**

**Product characteristics**

	<b>NA</b>	<b>SA</b>
Base material	HIPS	
Surface material	PU-leather	
Material thickness mm	1,9	2,03
Temperature stability	up to 60 °C	
Wet room suitability	■■■□	
Rolled packable *	✓	✓

\* Design sheets to be rolled with the decor side outwardly (both – NA and SA version). We recommend rolling not more than 3 sheets per carton (480 x 480 mm).

**Processing**

	<b>NA</b>	<b>SA</b>
Cutting, punching	✓	✓
Drilling	✓	✓
Sawing	✓	—
Milling	—	—
Laser cutting	✓	✓
Hot bending	✓	—
PVA compressible	✓	—
Smallest bending radius	150 mm	150 mm

**Extra equipment**

	<b>NA</b>	<b>SA</b>
Special formats	On request	
Further thicknesses	✓	✓
Cuttings	✓	✓
Magnetic from 3 sheets	✓	
PVA pre-treatment	✓	—

**Accessories**

SIBUKLE	Spatula A2
---------	------------

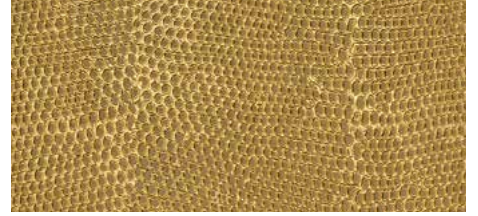
**Special colors**

—
---





Photo: © Kaupo Kikkas



**LL PEARL RAY Gold**  
2600 x 1000 / **NA** 17015 / **SA** 17016

## LEATHER-LINE

# LL PEARL RAY

2600 x 1000

### Product characteristics

	NA	SA
Base material	HIPS	
Surface material	PU-leather	
Material thickness mm	1,6	1,73
Temperature stability	up to 60 °C	
Wet room suitability	■■■□	
Rolled packable *	✓	✓

\* Design sheets to be rolled with the decor side outwardly (both – NA and SA version). We recommend rolling not more than 3 sheets per carton (480 x 480 mm).

### Processing

	NA	SA
Cutting, punching	✓	✓
Drilling	✓	✓
Sawing	✓	—
Milling	—	—
Laser cutting	✓	✓
Hot bending	✓	—
PVA compressible	✓	—
Smallest bending radius	150 mm	150 mm

### Extra equipment

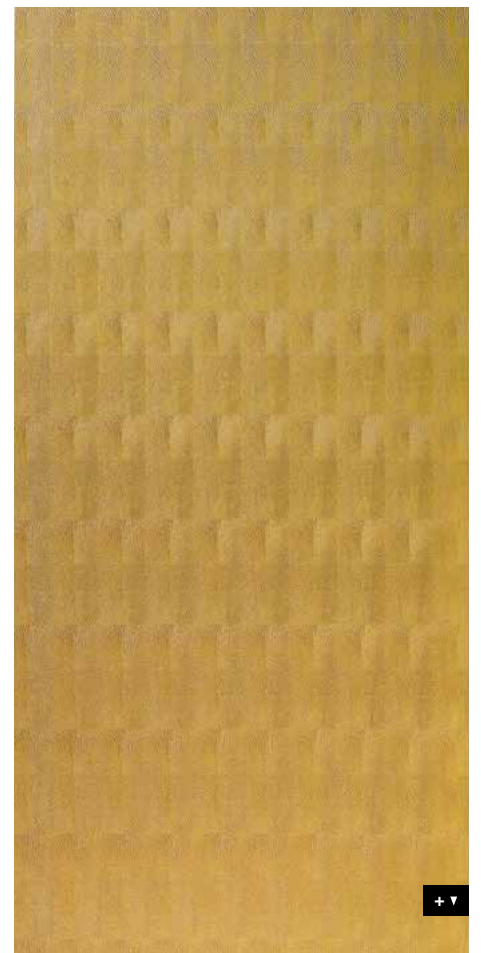
	NA	SA
Special formats	On request	
Further thicknesses	✓	✓
Cuttings	✓	✓
Magnetic from 3 sheets	✓	
PVA pre-treatment	✓	—

### Accessories

SIBUKLE	Spatula A1
---------	------------

### Special colors

On request
------------







**LL FLORAL White**  
2600 x 1000 / **NA** 13470 / **SA** 13473



Photo: Wipro

2600 x 1000



## LEATHER-LINE

# LL FLORAL

### Product characteristics

	NA	SA
Base material	HIPS	
Surface material	PU-leather	
Material thickness mm	2,1	2,23
Max. relief height mm	2,9	3,03
Temperature stability	up to 60 °C	
Wet room suitability	■■■■■	
Rolled packable *	✓	✓

\* Design sheets to be rolled with the decor side outwardly (both – NA and SA version). We recommend rolling not more than 3 sheets per carton (480 x 480 mm).

### Extra equipment

	NA	SA
Special formats	–	–
Further thicknesses	–	–
Cuttings	✓	✓
Magnetic from 3 sheets	✓	
PVA pre-treatment	✓	–

### Processing

	NA	SA
Cutting, punching	✓	✓
Drilling	✓	✓
Sawing	✓	–
Milling	–	–
Laser cutting	✓	✓
Hot bending	✓	–
PVA compressible	✓	–
Smallest bending radius	150 mm	150 mm

### Accessories

SIBUKLE	Spatula A2
---------	------------

### Special colors

On request
------------





LL FLORAL  
VINTAGE Silver/Silver

Photo: GARANTline



**LL FLORAL VINTAGE Silver/Silver**  
2600 x 1000 / **NA** I7266 / **SA** I7267



**LL FLORAL White/Silver matt**  
2600 x 1000 / **NA** I3418 / **SA** I3414



**LL FLORAL White/Gold matt**  
2600 x 1000 / **NA** I3419 / **SA** I3415



**LL FLORAL Black/Silver matt**  
2600 x 1000 / **NA** I3416 / **SA** I3412

## LEATHER-LINE

# LL FLORAL

2600 x 1000



### Product characteristics

	NA	SA
Base material	HIPS	
Surface material	PU-leather	
Material thickness mm	1,9	2,03
Max. relief height mm	2,9	3,03
Temperature stability	up to 60 °C	
Wet room suitability	■■■■□	
Rolled packable *	✓	✓

\* Design sheets to be rolled with the decor side outwardly (both – NA and SA version). We recommend rolling not more than 3 sheets per carton (480 x 480 mm).

### Processing

	NA	SA
Cutting, punching	✓	✓
Drilling	✓	✓
Sawing	✓	—
Milling	—	—
Laser cutting	✓	✓
Hot bending	✓	—
PVA compressible	✓	—
Smallest bending radius	150 mm	150 mm

### Extra equipment

	NA	SA
Special formats	—	—
Further thicknesses	—	—
Cuttings	✓	✓
Magnetic from 3 sheets	✓	
PVA pre-treatment	✓	—

### Accessories

SIBUKLE	Spatula A2
---------	------------

### Special colors

On request
------------





**LL CURVED Silver**

2600 x 1000 / **NA** 22805 / **SA** 22806



**LL CURVED Gold**

2600 x 1000 / **NA** 22803 / **SA** 22808



**LL CURVED Rose**

2600 x 1000 / **NA** 22804 / **SA** 22807

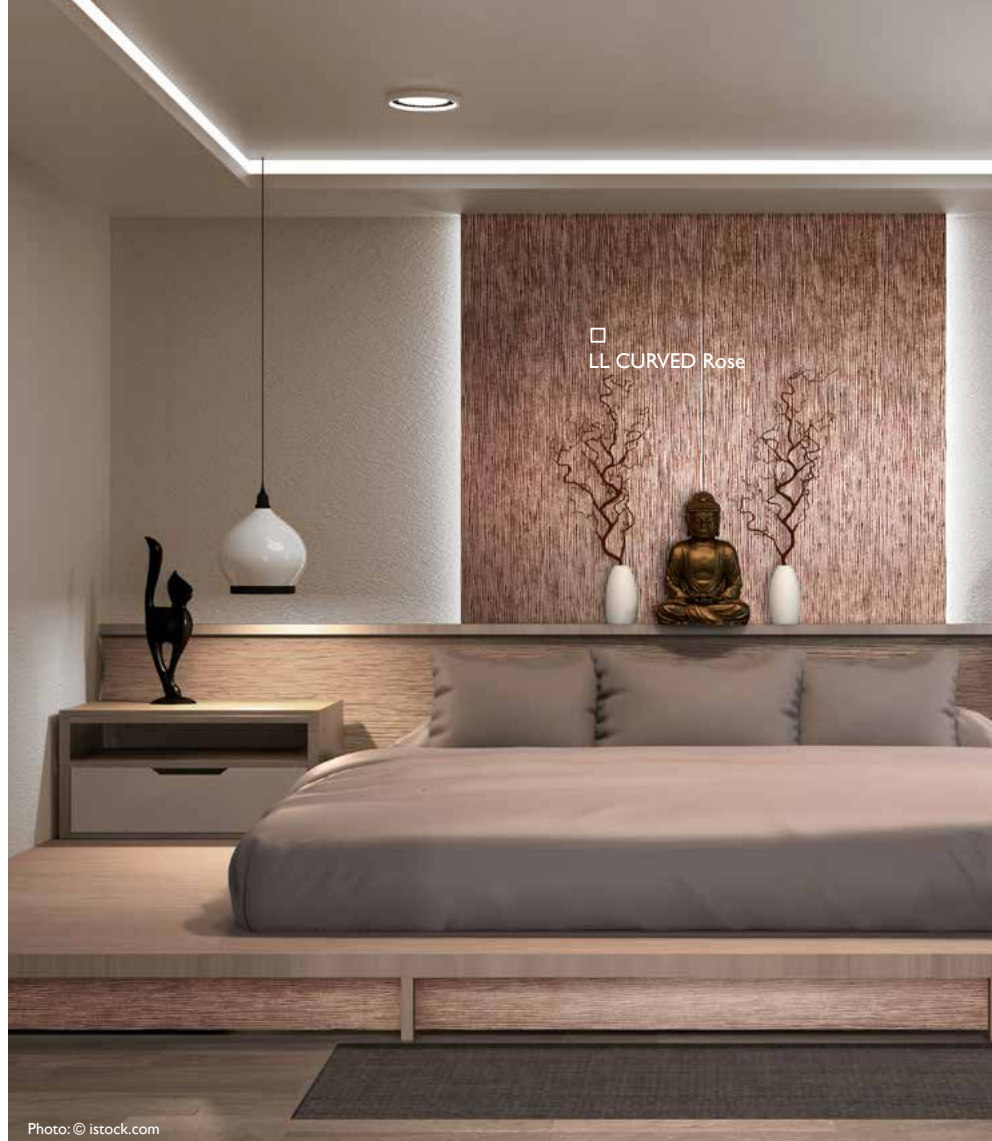


Photo: © istock.com

2600 x 1000



LEATHER-LINE

**LL CURVED**

**Product characteristics**

	NA	SA
Base material	HIPS	
Surface material	PU-leather	
Material thickness mm	1,7	1,83
Temperature stability	up to 60 °C	
Wet room suitability	■■■□	
Rolled packable *	✓	✓

\* Design sheets to be rolled with the decor side outwardly (both – NA and SA version). We recommend rolling not more than 3 sheets per carton (480 x 480 mm).

**Processing**

	NA	SA
Cutting, punching	✓	✓
Drilling	✓	✓
Sawing	✓	–
Milling	–	–
Laser cutting	✓	✓
Hot bending	✓	–
PVA compressible	✓	–
Smallest bending radius	150 mm	

**Extra equipment**

	NA	SA
Special formats	On request	
Further thicknesses	✓	✓
Cuttings	✓	✓
Magnetic from 3 sheets	✓	
PVA pre-treatment	✓	–

**Accessories**

SIBUKLE	Spatula A1
---------	------------

**Special colors**

–
---







LL GRID Silver



**LL GRID Silver**  
2600 x 1000 / **NA** 22811 / **SA** 22812



**LL GRID Gold**  
2600 x 1000 / **NA** 22809 / **SA** 22814



**LL GRID Rose**  
2600 x 1000 / **NA** 22810 / **SA** 22813

Photo: © istock.com

## LEATHER-LINE LL GRID

2600 x 1000

### Product characteristics

	NA	SA
Base material	HIPS	
Surface material	PU-leather	
Material thickness mm	1,7	1,83
Temperature stability	up to 60 °C	
Wet room suitability	■■■□	
Rolled packable *	✓	✓

\* Design sheets to be rolled with the decor side outwardly (both – NA and SA version). We recommend rolling not more than 3 sheets per carton (480 x 480 mm).

### Processing

	NA	SA
Cutting, punching	✓	✓
Drilling	✓	✓
Sawing	✓	–
Milling	–	–
Laser cutting	✓	✓
Hot bending	✓	–
PVA compressible	✓	–
Smallest bending radius	150 mm	

### Extra equipment

	NA	SA
Special formats	On request	
Further thicknesses	✓	✓
Cuttings	✓	✓
Magnetic from 3 sheets	✓	
PVA pre-treatment	✓	–

### Accessories

SIBUKLE	Spatula A I
---------	-------------

### Special colors

–
---





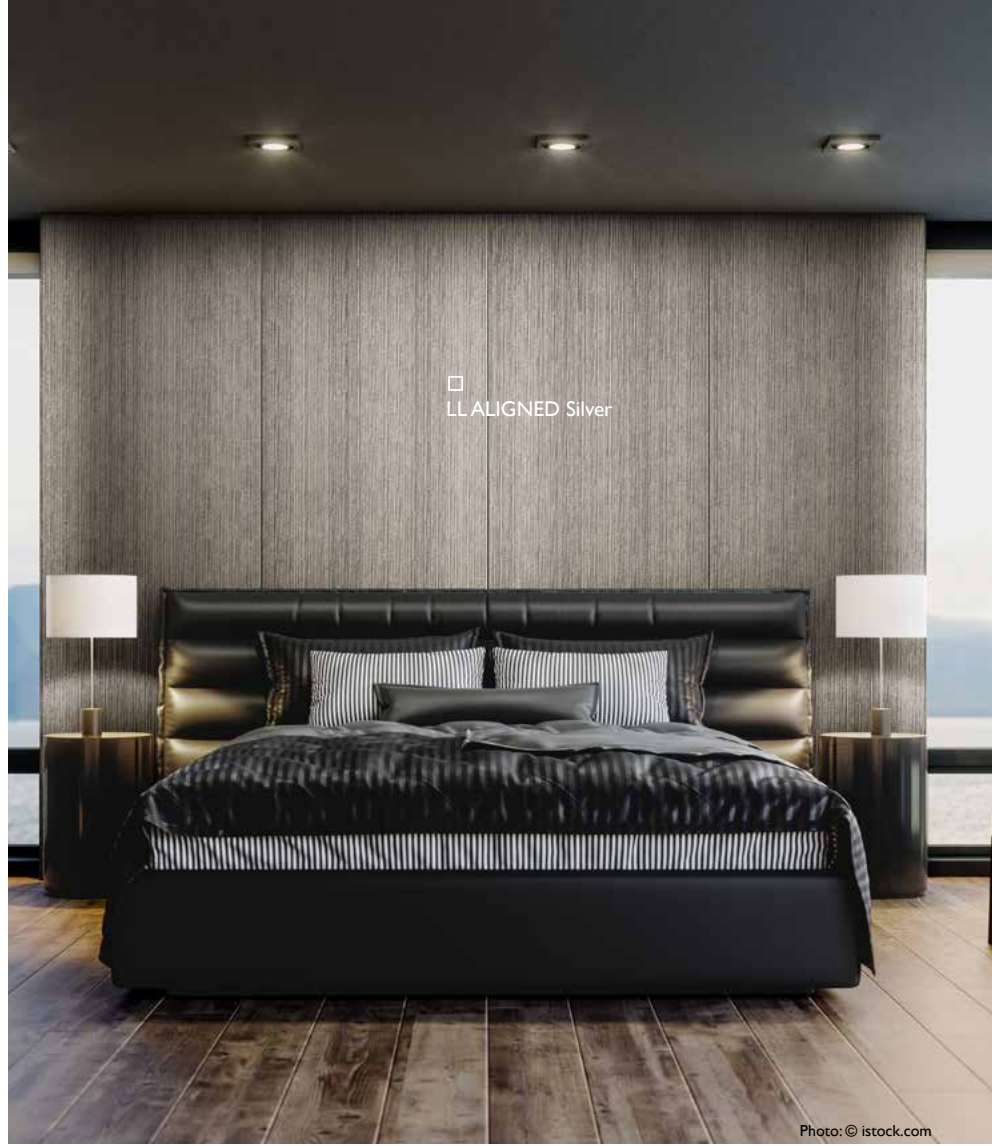
**LL ALIGNED Silver**  
2600 x 1000 / **NA** 22817 / **SA** 22818



**LL ALIGNED Gold**  
2600 x 1000 / **NA** 22815 / **SA** 22820



**LL ALIGNED Rose**  
2600 x 1000 / **NA** 22816 / **SA** 22819



□ LL ALIGNED Silver

Photo: © istock.com

2600 x 1000



## LEATHER-LINE

# LL ALIGNED

### Product characteristics

	NA	SA
Base material	HIPS	
Surface material	PU-leather	
Material thickness mm	1,7	1,83
Temperature stability	up to 60 °C	
Wet room suitability	■■■□	
Rolled packable *	✓	✓

\* Design sheets to be rolled with the decor side outwardly (both – NA and SA version). We recommend rolling not more than 3 sheets per carton (480 x 480 mm).

### Processing

	NA	SA
Cutting, punching	✓	✓
Drilling	✓	✓
Sawing	✓	—
Milling	—	—
Laser cutting	✓	✓
Hot bending	✓	—
PVA compressible	✓	—
Smallest bending radius	150 mm	

### Extra equipment

	NA	SA
Special formats	On request	
Further thicknesses	✓	✓
Cuttings	✓	✓
Magnetic from 3 sheets	✓	
PVA pre-treatment	✓	—

### Accessories

SIBUKLE	Spatula A1
---------	------------

### Special colors

—
---





□ LL ALIGNED Silver

□ LL ALIGNED Gold



# FABRIC- LINE

SIBU | DESIGN



CONTINUOUS PATTERN

**FL CUBE VELVET Bordeaux**  
2600 x 1000 / **NA** 22709 / **SA** 22719

CONTINUOUS PATTERN

**FL CUBE VELVET Pearl**  
2600 x 1000 / **NA** 22710 / **SA** 22720

Please consider the nap direction of the surface before further processing or product installation. If design panels are not installed in the same direction, there will be a visual color difference.



Photo: © istock.com

2600 x 1000



## FABRIC-LINE

## FL CUBE VELVET

## Product characteristics

	NA	SA
Base material	HIPS	
Surface material	PET fiber	
Material thickness mm	1,7	1,83
Max. relief height mm	2,2	2,33
Temperature stability	up to 60 °C	
Wet room suitability	■■■■	
Rolled packable *	✓	✓

\* Design sheets to be rolled with the decor side outwardly (both – NA and SA version). We recommend rolling not more than 3 sheets per carton (480 x 480 mm).

## Extra equipment

	NA	SA
Special formats	On request	
Cuttings	✓	✓
Magnetic from 3 sheets **	✓	
PVA pre-treatment	✓	–

\*\* Ground must be a SIBU metal foil SA (ref. 17637, self adhesive).

## Processing

	NA	SA
Cutting, punching	✓	✓
Drilling	✓	✓
Sawing	✓	–
Milling	–	–
Laser cutting	✓	✓
Hot bending	✓	–
PVA compressible	✓	–
Smallest bending radius	150 mm	

## Accessories

SIBUKLE	Spatula A2
---------	------------

## Special colors

On request
------------



FL CREPA VELVET Volcano



**FL CREPA VELVET Avocado**  
2600 x 1000 / **NA** 22705 / **SA** 22715



**FL CREPA VELVET Volcano**  
2600 x 1000 / **NA** 22706 / **SA** 22717

Please consider the nap direction of the surface before further processing or product installation. If design panels are not installed in the same direction, there will be a visual color difference.

Photo: © istock.com

## FABRIC-LINE

# FL CREPA VELVET

2600 x 1000

### Product characteristics

	NA	SA
Base material	HIPS	
Surface material	PET fiber	
Material thickness mm	1,7	1,83
Max. relief height mm	2,2	2,33
Temperature stability	up to 60 °C	
Wet room suitability	■■■■	
Rolled packable *	✓	✓

\* Design sheets to be rolled with the decor side outwardly (both – NA and SA version). We recommend rolling not more than 3 sheets per carton (480 x 480 mm).

### Processing

	NA	SA
Cutting, punching	✓	✓
Drilling	✓	✓
Sawing	✓	–
Milling	–	–
Laser cutting	✓	✓
Hot bending	✓	–
PVA compressible	✓	–
Smallest bending radius	150 mm	

### Extra equipment

	NA	SA
Special formats	On request	
Cuttings	✓	✓
Magnetic from 3 sheets **	✓	
PVA pre-treatment	✓	–

\*\* Ground must be a SIBU metal foil SA (ref. 17637, self adhesive).

### Accessories

SIBUKLE	Spatula A2
---------	------------

### Special colors

On request
------------





CONTINUOUS PATTERN

**FL COMB VELVET Curry**  
2600 x 1000 / **NA** 22695 / **SA** 22711

CONTINUOUS PATTERN

**FL COMB VELVET Pearl**  
2600 x 1000 / **NA** 22696 / **SA** 22712

Please consider the nap direction of the surface before further processing or product installation. If design panels are not installed in the same direction, there will be a visual color difference.



Photo: © istock.com

2600 x 1000



## FABRIC-LINE

## FL COMB VELVET

## Product characteristics

	NA	SA
Base material	HIPS	
Surface material	PET fiber	
Material thickness mm	1,7	1,83
Max. relief height mm	2,2	2,33
Temperature stability	up to 60 °C	
Wet room suitability	■■■■	
Rolled packable *	✓	✓

\* Design sheets to be rolled with the decor side outwardly (both – NA and SA version). We recommend rolling not more than 3 sheets per carton (480 x 480 mm).

## Extra equipment

	NA	SA
Special formats	On request	
Cuttings	✓	✓
Magnetic from 3 sheets **	✓	
PVA pre-treatment	✓	–

\*\* Ground must be a SIBU metal foil SA (ref. 17637, self adhesive).

## Processing

	NA	SA
Cutting, punching	✓	✓
Drilling	✓	✓
Sawing	✓	–
Milling	–	–
Laser cutting	✓	✓
Hot bending	✓	–
PVA compressible	✓	–
Smallest bending radius	150 mm	

## Accessories

SIBUKLE	Spatula A2
---------	------------

## Special colors

On request
------------



**FL SQUARE 2 VELVET Mocha**  
2600 x 1000 / **NA** 22703 / **SA** 22713



**FL SQUARE 2 VELVET Coal**  
2600 x 1000 / **NA** 22704 / **SA** 22714

Please consider the nap direction of the surface before further processing or product installation. If design panels are not installed in the same direction, there will be a visual color difference.

Photo: © istock.com

## FABRIC-LINE

# FL SQUARE 2 VELVET

2600 x 1000



### Product characteristics

	NA	SA
Base material	HIPS	
Surface material	PET fiber	
Material thickness mm	1,7	1,83
Max. relief height mm	2,2	2,33
Temperature stability	up to 60 °C	
Wet room suitability	■■■■■	
Rolled packable *	✓	✓

\* Design sheets to be rolled with the decor side outwardly (both – NA and SA version). We recommend rolling not more than 3 sheets per carton (480 x 480 mm).

### Processing

	NA	SA
Cutting, punching	✓	✓
Drilling	✓	✓
Sawing	✓	–
Milling	–	–
Laser cutting	✓	✓
Hot bending	✓	–
PVA compressible	✓	–
Smallest bending radius	150 mm	

### Extra equipment

	NA	SA
Special formats	On request	
Cuttings	✓	✓
Magnetic from 3 sheets **	✓	
PVA pre-treatment	✓	–

\*\* Ground must be a SIBU metal foil SA (ref. 17637, self adhesive).

### Accessories

SIBUKLE	Spatula A2
---------	------------

### Special colors

On request
------------





**FL LAVA VELVET Volcano**  
2600 x 1000 / **NA** 22707 / **SA** 22718



**FL LAVA VELVET Coal**  
2600 x 1000 / **NA** 22708 / **SA** 22716

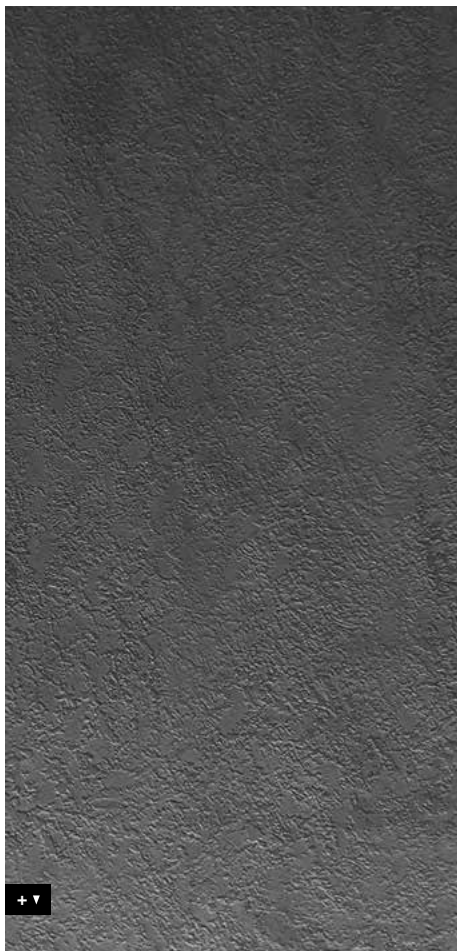
Please consider the nap direction of the surface before further processing or product installation. If design panels are not installed in the same direction, there will be a visual color difference.



□  
FL LAVA VELVET Volcano

Photo: © istock.com

2600 x 1000



## FABRIC-LINE

# FL LAVA VELVET

### Product characteristics

	NA	SA
Base material	HIPS	
Surface material	PET fiber	
Material thickness mm	1,7	1,83
Max. relief height mm	2,2	2,33
Temperature stability	up to 60 °C	
Wet room suitability	■■■■■	
Rolled packable *	✓	✓

\* Design sheets to be rolled with the decor side outwardly (both – NA and SA version). We recommend rolling not more than 3 sheets per carton (480 x 480 mm).

### Extra equipment

	NA	SA
Special formats	On request	
Cuttings	✓	✓
Magnetic from 3 sheets **	✓	
PVA pre-treatment	✓	–

\*\* Ground must be a SIBU metal foil SA (ref. 17637, self adhesive).

### Processing

	NA	SA
Cutting, punching	✓	✓
Drilling	✓	✓
Sawing	✓	–
Milling	–	–
Laser cutting	✓	✓
Hot bending	✓	–
PVA compressible	✓	–
Smallest bending radius	150 mm	

### Accessories

SIBUKLE	Spatula A2
---------	------------

### Special colors

On request
------------





□  
FL LAVA VELVET Volcano



# OPACO- LINE

SIBU | DESIGN





**OL MARBLE Alpine matt AR**  
2600 x 1000 / **NA** 22624 / **SA** 22632

PRS\*



□ OL MARBLE Alpine matt AR

Photo: © istock.com

2600 x 1000



+ ▼

## OPACO LINE

# OL MARBLE Alpine matt AR

### Product characteristics

	NA	SA
Surface material	PET	
Base material	PS	
Back side material	Paper	
Material thickness mm	2,3	2,43
Temperature stability	up to 60 °C	
Wet room suitability	■■■■□	
Abrasion resistance	■■■■■□	
Rolled packable	—	—

### Processing

	NA	SA
Cutting, punching	—	—
Drilling	✓	✓
Sawing, milling (supported by a panel)	✓	✓
Laser cutting	✓	✓
Hot bending	—	—
PVA compressible	✓	—
Smallest bending radius	1000 mm	1000 mm

### Extra equipment

	NA	SA
Special formats	On request	
Further thicknesses	✓	✓
Cuttings	✓	✓
Magnetic from 3 sheets**	✓	
PVA pre-treatment	—	—

### Accessories

SIBUKLE	Spatula A2
---------	------------

### Special colors

—
---

\* Prior to printing a corona or plasma treatment has to be carried out. Upon request available in pre-treated version.  
\*\* Ground must be a SIBU metal foil SA (ref. 17637, self adhesive).



□ OL GENESIS White matt AR



PRS\*

**OL GENESIS White matt AR**  
2600 x 1000 / **NA** 22626 / **SA** 22634

## OPACO LINE

# OL GENESIS White matt AR

2600 x 1000

### Product characteristics

	NA	SA
Surface material	PET	
Base material	PS	
Back side material	Paper	
Material thickness mm	2,3	2,43
Temperature stability	up to 60 °C	
Wet room suitability	■■■■□	
Abrasion resistance	■■■■■□	
Rolled packable	—	—

### Processing

	NA	SA
Cutting, punching	—	—
Drilling	✓	✓
Sawing, milling (supported by a panel)	✓	✓
Laser cutting	✓	✓
Hot bending	—	—
PVA compressible	✓	—
Smallest bending radius	1000 mm	1000 mm

### Extra equipment

	NA	SA
Special formats	On request	
Further thicknesses	✓	✓
Cuttings	✓	✓
Magnetic from 3 sheets **	✓	
PVA pre-treatment	—	—

### Accessories

SIBUKLE	Spatula A2
---------	------------

### Special colors

—
---

\* Prior to printing a corona or plasma treatment has to be carried out. Upon request available in pre-treated version.  
\*\* Ground must be a SIBU metal foil SA (ref. 17637, self adhesive).



+ ▼



PRS\*

**OL MARBLE White matt AR**  
2600 x 1000 / **NA** 22625 / **SA** 22633



□  
OL MARBLE White matt AR

Photo: © istock.com

2600 x 1000



## OPACO LINE

# OL MARBLE White matt AR

### Product characteristics

	NA	SA
Surface material	PET	
Base material	PS	
Back side material	Paper	
Material thickness mm	2,3	2,43
Temperature stability	up to 60 °C	
Wet room suitability	■■■■□	
Abrasion resistance	■■■■■□	
Rolled packable	—	—

### Processing

	NA	SA
Cutting, punching	—	—
Drilling	✓	✓
Sawing, milling (supported by a panel)	✓	✓
Laser cutting	✓	✓
Hot bending	—	—
PVA compressible	✓	—
Smallest bending radius	1000 mm	1000 mm

### Extra equipment

	NA	SA
Special formats	On request	
Further thicknesses	✓	✓
Cuttings	✓	✓
Magnetic from 3 sheets**	✓	
PVA pre-treatment	—	—

### Accessories

SIBUKLE	Spatula A2
---------	------------

### Special colors

—
---

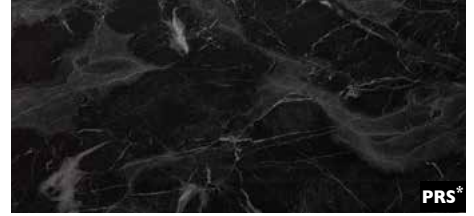
\* Prior to printing a corona or plasma treatment has to be carried out. Upon request available in pre-treated version.  
\*\* Ground must be a SIBU metal foil SA (ref. 17637, self adhesive).







□ OL MARBLE Black matt AR



PRS\*

**OL MARBLE Black matt AR**  
2600 x 1000 / **NA** 22627 / **SA** 22635

## OPACO LINE

# OL MARBLE Black matt AR

2600 x 1000

### Product characteristics

	NA	SA
Surface material	PET	
Base material	PS	
Back side material	Paper	
Material thickness mm	2,3	2,43
Temperature stability	up to 60 °C	
Wet room suitability	■■■■□	
Abrasion resistance	■■■■■□	
Rolled packable	—	—

### Processing

	NA	SA
Cutting, punching	—	—
Drilling	✓	✓
Sawing, milling (supported by a panel)	✓	✓
Laser cutting	✓	✓
Hot bending	—	—
PVA compressible	✓	—
Smallest bending radius	1000 mm	1000 mm

### Extra equipment

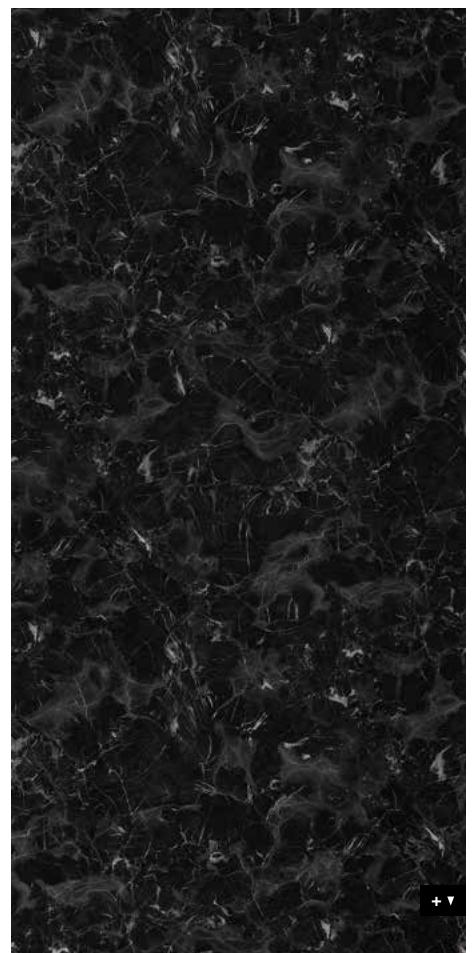
	NA	SA
Special formats	On request	
Further thicknesses	✓	✓
Cuttings	✓	✓
Magnetic from 3 sheets **	✓	
PVA pre-treatment	—	—

### Accessories

SIBUKLE	Spatula A2
---------	------------

### Special colors

—
---



\* Prior to printing a corona or plasma treatment has to be carried out. Upon request available in pre-treated version.  
\*\* Ground must be a SIBU metal foil SA (ref. 17637, self adhesive).



# SIBUGLAS

SIBU | DESIGN





PR+

**SG CURVED Silver AR+**  
2600 x 1000 / **NA** 20177 / **SA** 20215



PR+

**SG CURVED Gold AR+**  
2600 x 1000 / **NA** 20176 / **SA** 20214



PR+

**SG CURVED Rose AR+**  
2600 x 1000 / **NA** 20178 / **SA** 20216



Photo: © istock.com

2600 x 1000



+ ▾

SIBUGLAS **scratch-resistant**

# SG CURVED AR+

## Product characteristics

	NA	SA
Surface material = Base material	PMMA AR+	
Back side material	PU-leather	
Material thickness mm	2,9	3,03
Temperature stability	up to 60 °C	
Wet room suitability	■■■■	
Abrasion resistance	■■■■■■■■	
Rolled packable	—	—

## Processing

	NA	SA
Cutting, punching	—	—
Drilling	✓	✓
Sawing	✓	✓
Milling	—	—
Laser cutting	✓	✓
Hot bending	—	—
PVA compressible	✓	—
Smallest bending radius	1000 mm	

## Extra equipment

	NA	SA
Special formats	On request	
Further thicknesses	✓	✓
Cuttings	✓	✓
Magnetic from 3 sheets*	✓	
PVA pre-treatment	—	—

\* Ground must be a SIBU metal foil SA (ref. 17637, self adhesive).

## Accessories

SIBUKLE	Spatula A2
---------	------------

## Special colors

—
---



**SG ALIGNED Silver AR+**  
2600 x 1000 / **NA** 20180 / **SA** 20219



**SG ALIGNED Gold AR+**  
2600 x 1000 / **NA** 20179 / **SA** 20218



**SG ALIGNED Rose AR+**  
2600 x 1000 / **NA** 20181 / **SA** 20217

# SIBUGLAS scratch-resistant SG ALIGNED AR+

2600 x 1000

## Product characteristics

	NA	SA
Surface material = Base material	PMMA AR+	
Back side material	PU-leather	
Material thickness mm	2,9	3,03
Temperature stability	up to 60 °C	
Wet room suitability	■■■■■	
Abrasion resistance	■■■■■■■■■	
Rolled packable	—	—

## Processing

	NA	SA
Cutting, punching	—	—
Drilling	✓	✓
Sawing	✓	✓
Milling	—	—
Laser cutting	✓	✓
Hot bending	—	—
PVA compressible	✓	—
Smallest bending radius	1000 mm	

## Extra equipment

	NA	SA
Special formats	On request	
Further thicknesses	✓	✓
Cuttings	✓	✓
Magnetic from 3 sheets*	✓	
PVA pre-treatment	—	—

## Accessories

SIBUKLE	Spatula A2
---------	------------

## Special colors

—
---

\* Ground must be a SIBU metal foil SA (ref. 17637, self adhesive).





**SG GRID Silver AR+**  
2600 x 1000 / **NA** 20183 / **SA** 20222



**SG GRID Gold AR+**  
2600 x 1000 / **NA** 20182 / **SA** 20221

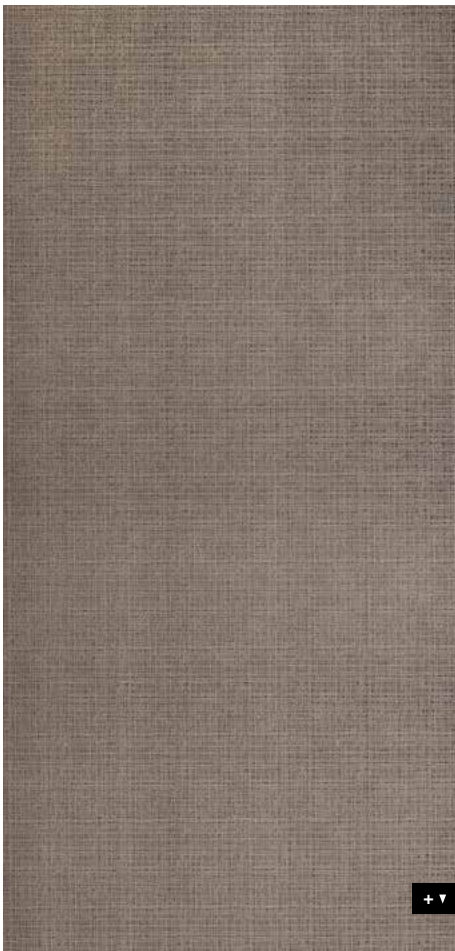


**SG GRID Rose AR+**  
2600 x 1000 / **NA** 20184 / **SA** 20220



Photo: © istock.com

2600 x 1000



**SIBUGLAS** scratch-resistant

# SG GRID AR+

## Product characteristics

	NA	SA
Surface material = Base material	PMMA AR+	
Back side material	PU-leather	
Material thickness mm	2,9	3,03
Temperature stability	up to 60 °C	
Wet room suitability	■■■■■	
Abrasion resistance	■■■■■■■■■	
Rolled packable	—	—

## Processing

	NA	SA
Cutting, punching	—	—
Drilling	✓	✓
Sawing	✓	✓
Milling	—	—
Laser cutting	✓	✓
Hot bending	—	—
PVA compressible	✓	—
Smallest bending radius	1000 mm	

## Extra equipment

	NA	SA
Special formats	On request	
Further thicknesses	✓	✓
Cuttings	✓	✓
Magnetic from 3 sheets*	✓	
PVA pre-treatment	—	—

\* Ground must be a SIBU metal foil SA (ref. 17637, self adhesive).

## Accessories

SIBUKLE	Spatula A2
---------	------------

## Special colors

—
---





□  
SG GENESIS  
Grey AR+

Photo: © istock.com



PR+

**SG GENESIS Grey AR+**  
2600 x 1000 / **NA** 20185 / **SA** 20223



PR+

**SG GENESIS White AR+**  
2600 x 1000 / **NA** 23177 / **SA** 23180

SIBUGLAS **scratch-resistant**

# SG GENESIS Grey AR+

2600 x 1000

## Product characteristics

	NA	SA
Surface material = Base material	PMMA AR+	
Back side material	Paper	
Material thickness mm	2,3	2,43
Temperature stability	up to 60 °C	
Wet room suitability	■■■■■	
Abrasion resistance	■■■■■■■	
Rolled packable	—	—

## Processing

	NA	SA
Cutting, punching	—	—
Drilling	✓	✓
Sawing, milling (supported by a panel)	✓	✓
Laser cutting	✓	✓
Hot bending	—	—
PVA compressible	✓	—
Smallest bending radius	1000 mm	

## Extra equipment

	NA	SA
Special formats	On request	
Further thicknesses	✓	✓
Cuttings	✓	✓
Magnetic from 3 sheets *	✓	
PVA pre-treatment	—	—

\* Ground must be a SIBU metal foil SA (ref. 17637, self adhesive).

## Accessories

SIBUKLE	Spatula A2
---------	------------

## Special colors

—
---





**SG MARBLE Brown AR+**  
2600 x 1000 / **NA** 19331 / **SA** 19342



□ SG MARBLE Brown AR+

Photo: © istock.com

2600 x 1000



SIBUGLAS **scratch-resistant**

# SG MARBLE Brown AR+

## Product characteristics

	NA	SA
Surface material = Base material	PMMA AR+	
Back side material	Paper	
Material thickness mm	2,3	2,43
Temperature stability	up to 60 °C	
Wet room suitability	■■■■■	
Abrasion resistance	■■■■■■■	
Rolled packable	—	—

## Processing

	NA	SA
Cutting, punching	—	—
Drilling	✓	✓
Sawing, milling (supported by a panel)	✓	✓
Laser cutting	✓	✓
Hot bending	—	—
PVA compressible	✓	—
Smallest bending radius	1000 mm	1000 mm

## Extra equipment

	NA	SA
Special formats	On request	
Further thicknesses	✓	✓
Cuttings	✓	✓
Magnetic from 3 sheets *	✓	
PVA pre-treatment	—	—

\* Ground must be a SIBU metal foil SA (ref. 17637, self adhesive).

## Accessories

SIBUKLE	Spatula A2
---------	------------

## Special colors

—
---





□ SG MARBLE Alpine AR+

Photo: © istock.com



PR+

**SG MARBLE Alpine AR+**  
2600 x 1000 / **NA** 19329 / **SA** 19340

SIBUGLAS **scratch-resistant**

# SG MARBLE Alpine AR+

2600 x 1000

## Product characteristics

	NA	SA
Surface material = Base material	PMMA AR+	
Back side material	Paper	
Material thickness mm	2,3	2,43
Temperature stability	up to 60 °C	
Wet room suitability	■■■■■	
Abrasion resistance	■■■■■■■	
Rolled packable	—	—

## Processing

	NA	SA
Cutting, punching	—	—
Drilling	✓	✓
Sawing, milling (supported by a panel)	✓	✓
Laser cutting	✓	✓
Hot bending	—	—
PVA compressible	✓	—
Smallest bending radius	1000 mm	1000 mm

## Extra equipment

	NA	SA
Special formats	On request	
Further thicknesses	✓	✓
Cuttings	✓	✓
Magnetic from 3 sheets *	✓	
PVA pre-treatment	—	—

\* Ground must be a SIBU metal foil SA (ref. 17637, self adhesive).

## Accessories

SIBUKLE	Spatula A2
---------	------------

## Special colors

—
---



+ ▼





**SG MARBLE Black AR+**  
2600 x 1000 / **NA** 19330 / **SA** 19341

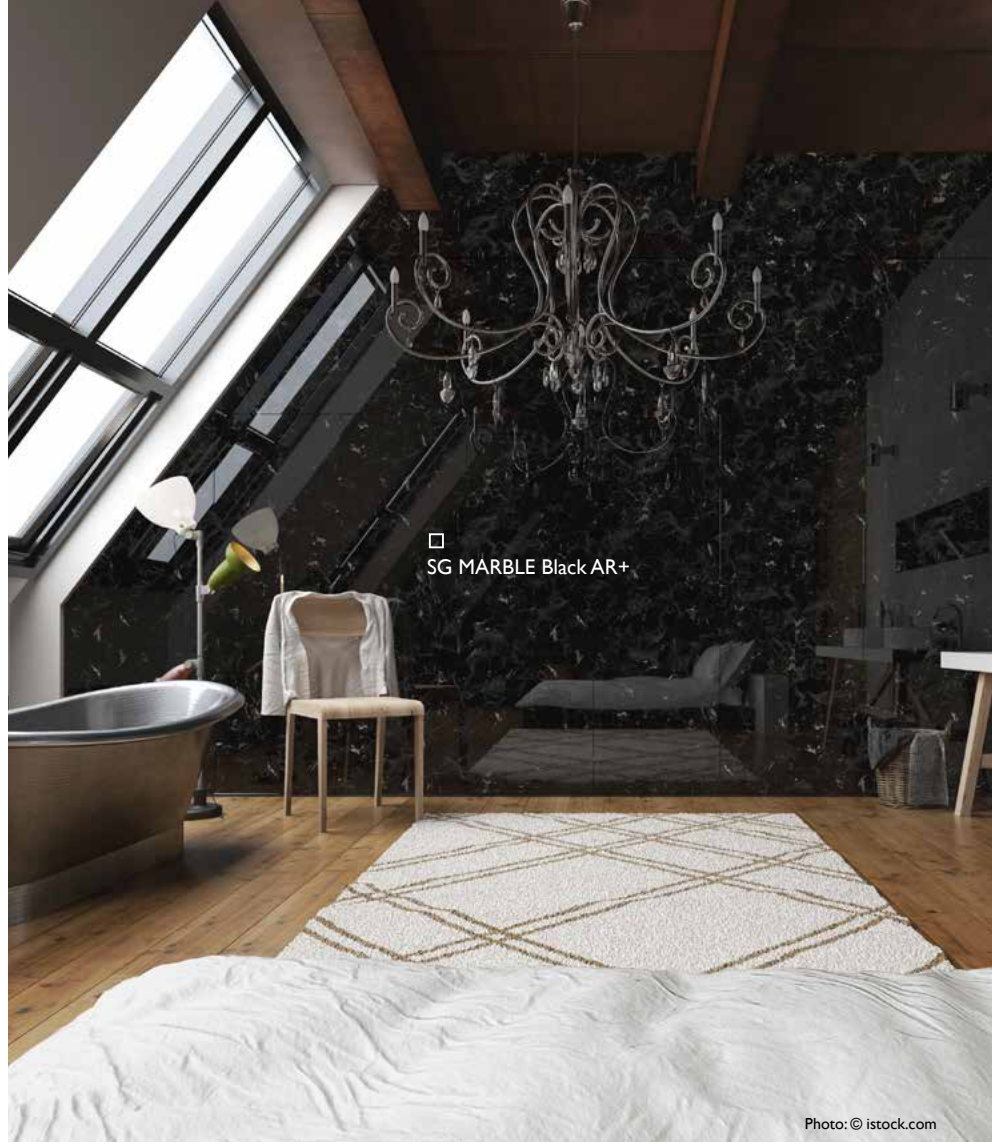
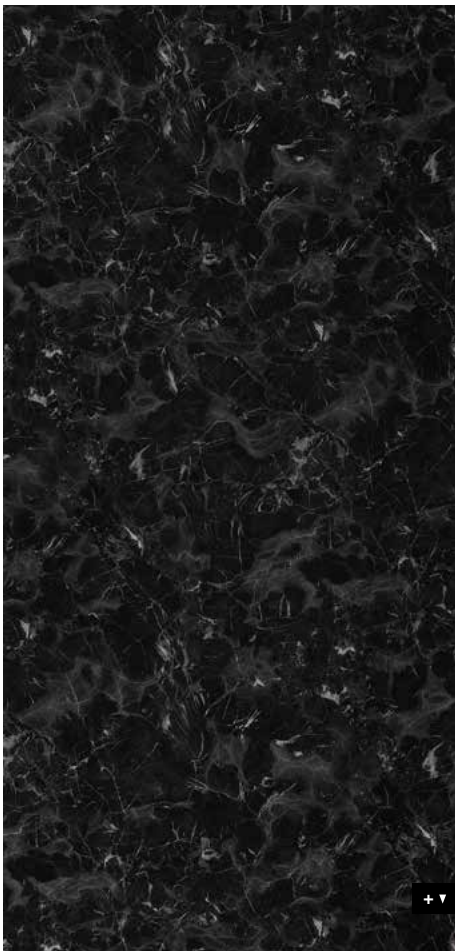


Photo: © istock.com

2600 x 1000



SIBUGLAS **scratch-resistant**

# SG MARBLE Black AR+

## Product characteristics

	NA	SA
Surface material = Base material	PMMA AR+	
Back side material	Paper	
Material thickness mm	2,3	2,43
Temperature stability	up to 60 °C	
Wet room suitability	■■■■■	
Abrasion resistance	■■■■■■■	
Rolled packable	—	—

## Processing

	NA	SA
Cutting, punching	—	—
Drilling	✓	✓
Sawing, milling (supported by a panel)	✓	✓
Laser cutting	✓	✓
Hot bending	—	—
PVA compressible	✓	—
Smallest bending radius	1000 mm	1000 mm

## Extra equipment

	NA	SA
Special formats	On request	
Further thicknesses	✓	✓
Cuttings	✓	✓
Magnetic from 3 sheets *	✓	
PVA pre-treatment	—	—

\* Ground must be a SIBU metal foil SA (ref. 17637, self adhesive).

## Accessories

SIBUKLE	Spatula A2
---------	------------

## Special colors

—
---



Photo: © fotolia.com



PR+

**SG MARBLE White AR+**  
2600 x 1000 / **NA** I9334 / **SA** I9345

SIBUGLAS **scratch-resistant**

# SG MARBLE White AR+

2600 x 1000

## Product characteristics

	NA	SA
Surface material = Base material	PMMA AR+	
Back side material	Paper	
Material thickness mm	2,3	2,43
Temperature stability	up to 60 °C	
Wet room suitability	■■■■■	
Abrasion resistance	■■■■■■■	
Rolled packable	—	—

## Processing

	NA	SA
Cutting, punching	—	—
Drilling	✓	✓
Sawing, milling (supported by a panel)	✓	✓
Laser cutting	✓	✓
Hot bending	—	—
PVA compressible	✓	—
Smallest bending radius	1000 mm	1000 mm

## Extra equipment

	NA	SA
Special formats	On request	
Further thicknesses	✓	✓
Cuttings	✓	✓
Magnetic from 3 sheets *	✓	
PVA pre-treatment	—	—

\* Ground must be a SIBU metal foil SA (ref. I7637, self adhesive).

## Accessories

SIBUKLE	Spatula A2
---------	------------

## Special colors

—
---



+ ▼



PR+

**SG MARBLE Grey AR+**  
2600 x 1000 / **NA** 19333 / **SA** 19344



SG MARBLE Grey AR+

Photo: © shutterstock.com

2600 x 1000



SIBUGLAS **scratch-resistant**

# SG MARBLE Grey AR+

## Product characteristics

	NA	SA
Surface material = Base material	PMMAAR+	
Back side material	Paper	
Material thickness mm	2,3	2,43
Temperature stability	up to 60 °C	
Wet room suitability	■■■■■	
Abrasion resistance	■■■■■■■	
Rolled packable	—	—

## Processing

	NA	SA
Cutting, punching	—	—
Drilling	✓	✓
Sawing, milling (supported by a panel)	✓	✓
Laser cutting	✓	✓
Hot bending	—	—
PVA compressible	✓	—
Smallest bending radius	1000 mm	1000 mm

## Extra equipment

	NA	SA
Special formats	On request	
Further thicknesses	✓	✓
Cuttings	✓	✓
Magnetic from 3 sheets *	✓	
PVA pre-treatment	—	—

\* Ground must be a SIBU metal foil SA (ref. 17637, self adhesive).

## Accessories

SIBUKLE	Spatula A2
---------	------------

## Special colors

—
---





□ SG MARBLE Emperador AR+

Photo: © istock.com



PR+

**SG MARBLE Emperador AR+**  
2600 x 1000 / **NA** I9332 / **SA** I9343

SIBUGLAS **scratch-resistant**

# SG MARBLE Emperador AR+

2600 x 1000

## Product characteristics

	NA	SA
Surface material = Base material	PMMA AR+	
Back side material	Paper	
Material thickness mm	2,3	2,43
Temperature stability	up to 60 °C	
Wet room suitability	■■■■■	
Abrasion resistance	■■■■■■■	
Rolled packable	—	—

## Processing

	NA	SA
Cutting, punching	—	—
Drilling	✓	✓
Sawing, milling (supported by a panel)	✓	✓
Laser cutting	✓	✓
Hot bending	—	—
PVA compressible	✓	—
Smallest bending radius	1000 mm	1000 mm

## Extra equipment

	NA	SA
Special formats	On request	
Further thicknesses	✓	✓
Cuttings	✓	✓
Magnetic from 3 sheets *	✓	
PVA pre-treatment	—	—

\* Ground must be a SIBU metal foil SA (ref. I7637, self adhesive).

## Accessories

SIBUKLE	Spatula A2
---------	------------

## Special colors

—
---

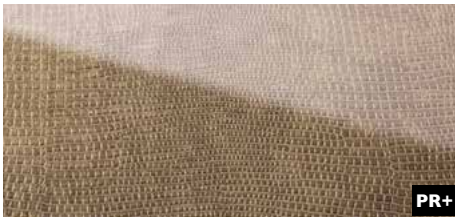




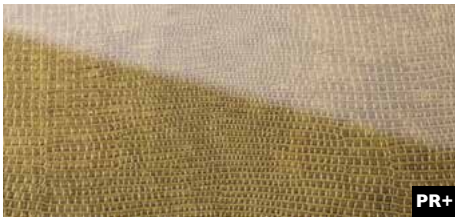
**SG LEGUAN Bianco met AR+**  
2600 x 1000 / **NA** 19304 / **SA** 19305



**SG LEGUAN Silver AR+**  
2600 x 1000 / **NA** 16975 / **SA** 16979



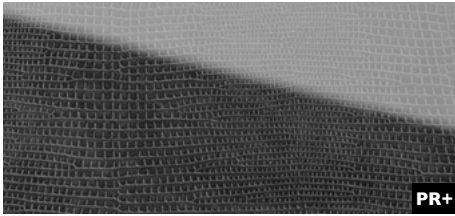
**SG LEGUAN Silk AR+**  
2600 x 1000 / **NA** 20275 / **SA** 20276



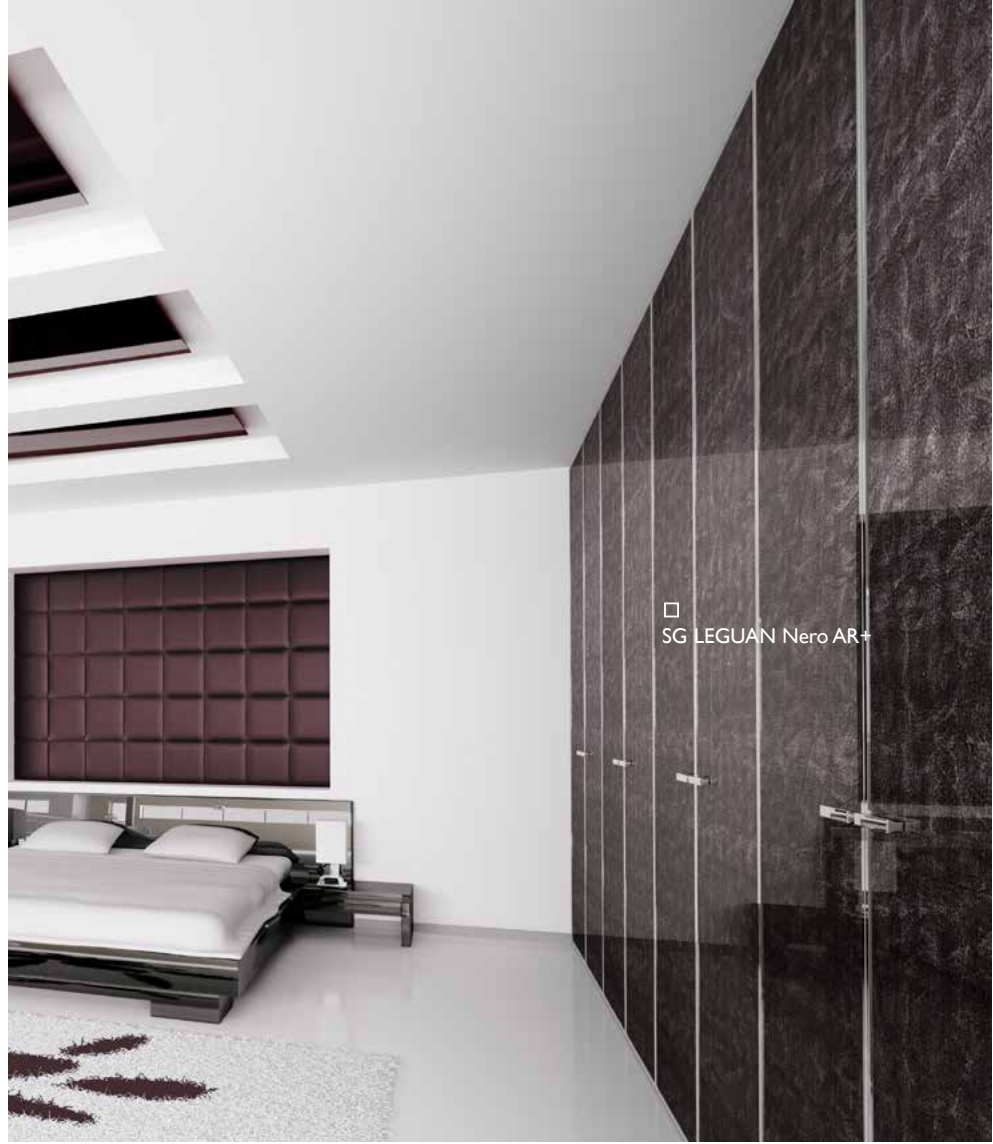
**SG LEGUAN Gold AR+**  
2600 x 1000 / **NA** 16977 / **SA** 16982



**SG LEGUAN Copper AR+**  
2600 x 1000 / **NA** 16976 / **SA** 16981



**SG LEGUAN Nero AR+**  
2600 x 1000 / **NA** 18089 / **SA** 18095



## SIBUGLAS scratch-resistant SG LEGUAN AR+

### Product characteristics

	NA	SA
Surface material = Base material	PMMA AR+	
Back side material	PU-leather	
Material thickness mm	2,8	2,93
Temperature stability	up to 60 °C	
Wet room suitability	■■■■■	
Abrasion resistance	■■■■■■■	
Rolled packable	—	—

### Processing

	NA	SA
Cutting, punching	—	—
Drilling	✓	✓
Sawing (supported by a panel)	✓	✓
Milling	—	—
Laser cutting	✓	✓
Hot bending	—	—
PVA compressible	✓	—
Smallest bending radius	1000 mm	1000 mm

### Extra equipment

	NA	SA
Special formats	On request	
Further thicknesses	✓	✓
Cuttings	✓	✓
Magnetic from 3 sheets *	✓	
PVA pre-treatment	—	—

### Accessories

SIBUKLE	Spatula A2
---------	------------

### Special colors

On request
------------

\* Ground must be real metal or a SIBU metal foil SA (ref. 17637, self adhesive).





□ SG VINTAGE Copper AR+



**SG VINTAGE Silver AR+**  
2600 x 1000 / **NA** 17197 / **SA** 17199



**SG VINTAGE Copper AR+**  
2600 x 1000 / **NA** 17198 / **SA** 17200

Photo: © tamix | I5 - fotolia.com

# SIBUGLAS scratch-resistant

## SG VINTAGE AR+

2600 x 1000

### Product characteristics

	NA	SA
Surface material = Base material	PMMA AR+	
Back side material	PU-leather	
Material thickness mm	2,8	2,93
Temperature stability	up to 60 °C	
Wet room suitability	■■■■■	
Abrasion resistance	■■■■■■■■■	
Rolled packable	—	—

### Processing

	NA	SA
Cutting, punching	—	—
Drilling	✓	✓
Sawing (supported by a panel)	✓	✓
Milling	—	—
Laser cutting	✓	✓
Hot bending	—	—
PVA compressible	✓	—
Smallest bending radius	1000 mm	1000 mm

### Extra equipment

	NA	SA
Special formats	On request	
Further thicknesses	✓	✓
Cuttings	✓	✓
Magnetic from 3 sheets *	✓	
PVA pre-treatment	—	—

### Accessories

SIBUKLE	Spatula A2
---------	------------

### Special colors

—
---

\* Ground must be real metal or a SIBU metal foil SA (ref. 17637, self adhesive).







PR+

**SG LUXURY Gold AR+**  
2600 x 1000 / **NA** 17819 / **SA** 17840



PR+

**SG LUXURY Bronze AR+**  
2600 x 1000 / **NA** 17820 / **SA** 17841



□ SG LUXURY Gold AR+

2600 x 1000



+ ▾

SIBUGLAS **scratch-resistant**

# SG LUXURY AR+

## Product characteristics

	NA	SA
Surface material = Base material	PMMA AR+	
Back side material	PU-leather	
Material thickness mm	3,1	3,23
Temperature stability	up to 60 °C	
Wet room suitability	■■■■■	
Abrasion resistance	■■■■■■■	
Rolled packable	—	—

## Processing

	NA	SA
Cutting, punching	—	—
Drilling	✓	✓
Sawing (supported by a panel)	✓	✓
Milling	—	—
Laser cutting	✓	✓
Hot bending	—	—
PVA compressible	✓	—
Smallest bending radius	1000 mm	1000 mm

## Extra equipment

	NA	SA
Special formats	On request	
Further thicknesses	✓	✓
Cuttings	✓	✓
Magnetic from 3 sheets *	✓	
PVA pre-treatment	—	—

\* Ground must be real metal or a SIBU metal foil SA (ref. 17637, self adhesive).

## Accessories

SIBUKLE	Spatula A2
---------	------------

## Special colors

On request
------------



□ SG OLD Platin AR+



PR+

**SG OLD Platin AR+**  
2600 x 1000 / **NA** 18067 / **SA** 18001

SIBUGLAS **scratch-resistant**

# SG OLD Platin AR+

2600 x 1000

## Product characteristics

	NA	SA
Surface material = Base material	PMMA AR+	
Back side material	PU-leather	
Material thickness mm	3,1	3,23
Temperature stability	up to 60 °C	
Wet room suitability	■■■■■	
Abrasion resistance	■■■■■■■	
Rolled packable	—	—

## Processing

	NA	SA
Cutting, punching	—	—
Drilling	✓	✓
Sawing (supported by a panel)	✓	✓
Milling	—	—
Laser cutting	✓	✓
Hot bending	—	—
PVA compressible	✓	—
Smallest bending radius	1000 mm	1000 mm

## Extra equipment

	NA	SA
Special formats	On request	
Further thicknesses	✓	✓
Cuttings	✓	✓
Magnetic from 3 sheets *	✓	
PVA pre-treatment	—	—

## Accessories

SIBUKLE	Spatula A2
---------	------------

## Special colors

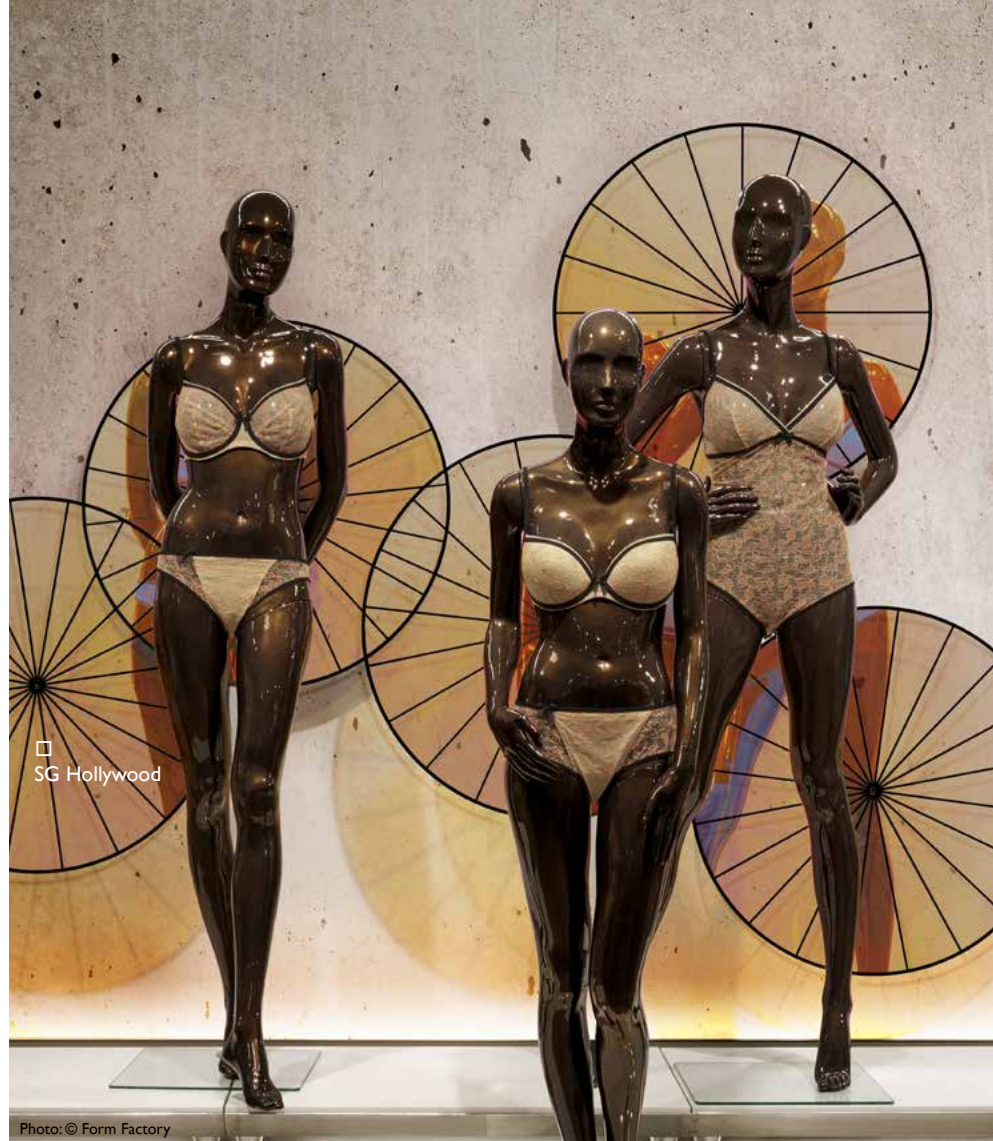
—
---

\* Ground must be real metal or a SIBU metal foil SA (ref. 17637, self adhesive).

+ ▼

**SG Hollywood**  
2600 x 1000 / NA 23116

On the protective film of the reverse side is a label "Reverse side / Processing side". SG Hollywood always has to be processed from the reverse side.



SG Hollywood

Photo: © Form Factory

# SIBUGLAS SG Hollywood

## Product characteristics

	NA
Surface material = Base material	PMMA
Back side material	PET
Material thickness mm	3,1
Temperature stability	up to 60 °C
Wet room suitability	■■■■■
Abrasion resistance	■■■■□□
Rolled packable	—

## Processing

	NA
Cutting, punching	—
Drilling	✓
Sawing, milling (supported by a panel)	✓
Laser cutting	✓
Hot bending*	On request
Thermoforming	On request
Smallest bending radius	1000 mm

\* Only an inner corner on the visible side is possible by heating the reverse side!

## Extra equipment

	NA
Special formats	On request
Further thicknesses	On request
Cuttings	✓

## Special colors

—
---





□ SG Hollywood



# WOOD- LINE

SIBU | DESIGN





PRS\*

**WL Carbonized Wood**  
2600 x 1000 / **NA** 20157 / **SA** 20224



□  
WL Carbonized Wood

Photo: © fotolia.com

2600 x 1000



WOOD-LINE

# WL Carbonized Wood

## Product characteristics

	NA	SA
Base material	HIPS	
Surface material	impregnated paper	
Material thickness mm	1,3	1,43
Temperature stability	up to 60 °C	
Wet room suitability	■■■□	
Abrasion resistance	■■■■□□	
Rolled packable **	✓	✓

## Processing

	NA	SA
Cutting, punching	✓	✓
Drilling	✓	✓
Sawing, milling	✓	—
Laser cutting	✓	✓
Hot bending	✓	—
Thermoforming	—	—
PVA compressible	✓	—
Smallest bending radius	150 mm	

## Extra equipment

	NA	SA
Special formats	On request	
Further thicknesses	✓	✓
Cuttings	✓	✓
Magnetic from 3 sheets™	✓	
PVA pre-treatment	✓	—

## Accessories

SIBUKLE	Spatula A1
---------	------------

## Special colors

—
---



PRS\*

**WL Wenge Wood**  
2600 x 1000 / **NA** 19016 / **SA** 19027

## WOOD-LINE

# WL Wenge Wood

2600 x 1000



### Product characteristics

	NA	SA
Base material	HIPS	
Surface material	impregnated paper	
Material thickness mm	1,2	1,33
Temperature stability	up to 60 °C	
Wet room suitability	■■■■□	
Abrasion resistance	■■■■□□□	
Rolled packable **	✓	✓

### Processing

	NA	SA
Cutting, punching	✓	✓
Drilling	✓	✓
Sawing, milling	✓	—
Laser cutting	✓	✓
Hot bending	✓	—
Thermoforming	—	—
PVA compressible	✓	—
Smallest bending radius	150 mm	150 mm

### Extra equipment

	NA	SA
Special formats	On request	
Further thicknesses	✓	✓
Cuttings	✓	✓
Magnetic from 3 sheets	✓	
PVA pre-treatment	✓	—

### Accessories

SIBUKLE	Spatula A I
---------	-------------

### Special colors

—
---

\* Prior to printing a corona or plasma treatment has to be carried out.  
Upon request available in pre-treated version.

\*\* Design sheets are to be rolled with the patterned side on the inside  
(applies for both the NA and SA versions). We recommend that not more than  
3 sheets be rolled per carton (480 x 480 mm).



PRS\*

**WL Maple Alpine**

2600 x 1000 / **NA** I9018 / **SA** I9029



□ WL Maple Alpine

Photo: © iStock.com

2600 x 1000



WOOD-LINE

**WL Maple Alpine**

**Product characteristics**

	NA	SA
Base material	HIPS	
Surface material	impregnated paper	
Material thickness mm	1,3	1,43
Temperature stability	up to 60 °C	
Wet room suitability	■■■□	
Abrasion resistance	■■■■□□	
Rolled packable **	✓	✓

**Processing**

	NA	SA
Cutting, punching	✓	✓
Drilling	✓	✓
Sawing, milling	✓	—
Laser cutting	✓	✓
Hot bending	✓	—
Thermoforming	—	—
PVA compressible	✓	—
Smallest bending radius	150 mm	150 mm

**Extra equipment**

	NA	SA
Special formats	On request	
Further thicknesses	✓	✓
Cuttings	✓	✓
Magnetic from 3 sheets	✓	
PVA pre-treatment	✓	—

**Accessories**

SIBUKLE	Spatula A1
---------	------------

**Special colors**

—
---

+ ▼

\* Prior to printing a corona or plasma treatment has to be carried out. Upon request available in pre-treated version.

\*\* Design sheets are to be rolled with the patterned side on the inside (applies for both the NA and SA versions). We recommend that not more than 3 sheets be rolled per carton (480 x 480 mm).





□  
WL Nutwood



PRS\*

**WL Nutwood**  
2600 x 1000 / **NA** 19019 / **SA** 19030

## WOOD-LINE

# WL Nutwood

2600 x 1000

### Product characteristics

	NA	SA
Base material	HIPS	
Surface material	impregnated paper	
Material thickness mm	1,3	1,43
Temperature stability	up to 60 °C	
Wet room suitability	■■■■□	
Abrasion resistance	■■■■□□	
Rolled packable **	✓	✓

### Processing

	NA	SA
Cutting, punching	✓	✓
Drilling	✓	✓
Sawing, milling	✓	—
Laser cutting	✓	✓
Hot bending	✓	—
Thermoforming	—	—
PVA compressible	✓	—
Smallest bending radius	150 mm	150 mm

### Extra equipment

	NA	SA
Special formats	On request	
Further thicknesses	✓	✓
Cuttings	✓	✓
Magnetic from 3 sheets	✓	
PVA pre-treatment	✓	—

### Accessories

SIBUKLE	Spatula A1
---------	------------

### Special colors

—
---

\* Prior to printing a corona or plasma treatment has to be carried out.  
Upon request available in pre-treated version.

\*\* Design sheets are to be rolled with the patterned side on the inside  
(applies for both the NA and SA versions). We recommend that not more  
than 3 sheets be rolled per carton (480 x 480 mm).



PRS\*

**WL Nutwood Country**  
2600 x 1000 / **NA** 19017 / **SA** 19028



□ WL Nutwood Country

Photo: © iStock.com

2600 x 1000



+ ▾

## WOOD-LINE

# WL Nutwood Country

### Product characteristics

	NA	SA
Base material	HIPS	
Surface material	impregnated paper	
Material thickness mm	1,3	1,43
Temperature stability	up to 60 °C	
Wet room suitability	■■■■□	
Abrasion resistance	■■■■□□	
Rolled packable **	✓	✓

### Processing

	NA	SA
Cutting, punching	✓	✓
Drilling	✓	✓
Sawing, milling	✓	—
Laser cutting	✓	✓
Hot bending	✓	—
Thermoforming	—	—
PVA compressible	✓	—
Smallest bending radius	150 mm	150 mm

### Extra equipment

	NA	SA
Special formats	On request	
Further thicknesses	✓	✓
Cuttings	✓	✓
Magnetic from 3 sheets	✓	
PVA pre-treatment	✓	—

### Accessories

SIBUKLE	Spatula A1
---------	------------

### Special colors

—
---

\* Prior to printing a corona or plasma treatment has to be carried out. Upon request available in pre-treated version.

\*\* Design sheets are to be rolled with the patterned side on the inside (applies for both the NA and SA versions). We recommend that not more than 3 sheets be rolled per carton (480 x 480 mm).



□  
WL Nutwood Country





PRS\*

**WL Sessile OAK**

2600 x 1000 / **NA** 22786 / **SA** 22787



□ WL Sessile OAK

Photo: © iStock.com

2600 x 1000



+ ▼

WOOD-LINE

**WL Sessile OAK**

**Product characteristics**

	NA	SA
Base material	HIPS	
Surface material	impregnated paper	
Material thickness mm	1,3	1,43
Temperature stability	up to 60 °C	
Wet room suitability	■■■■□	
Abrasion resistance	■■■■■□□	
Rolled packable **	✓	✓

**Processing**

	NA	SA
Cutting, punching	✓	✓
Drilling	✓	✓
Sawing, milling	✓	—
Laser cutting	✓	✓
Hot bending	✓	—
Thermoforming	—	—
PVA compressible	✓	—
Smallest bending radius	150 mm	150 mm

**Extra equipment**

	NA	SA
Special formats	On request	
Further thicknesses	✓	✓
Cuttings	✓	✓
Magnetic from 3 sheets	✓	
PVA pre-treatment	✓	—

**Accessories**

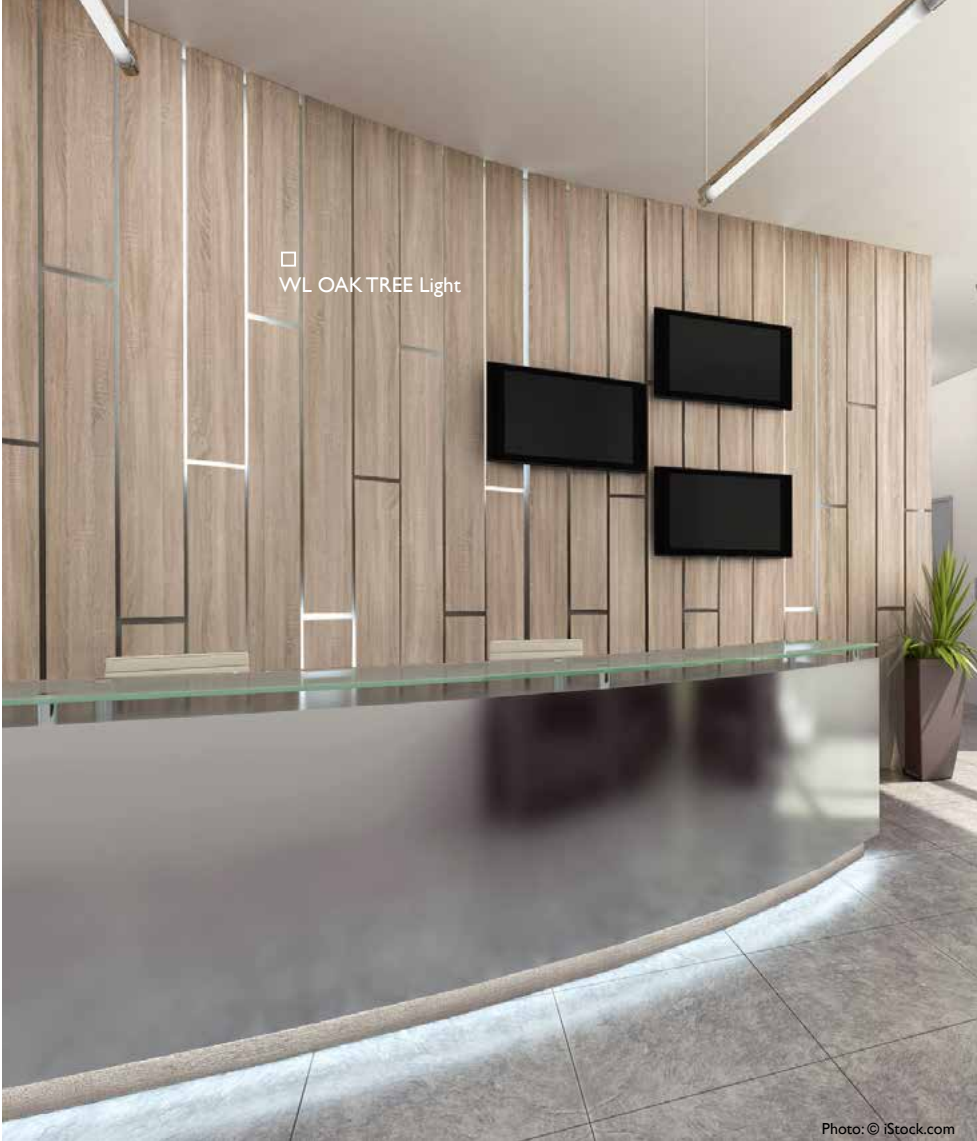
SIBUKLE	Spatula A1
---------	------------

**Special colors**

—
---

\* Prior to printing a corona or plasma treatment has to be carried out. Upon request available in pre-treated version.

\*\* Design sheets are to be rolled with the patterned side on the inside (applies for both the NA and SA versions). We recommend that not more than 3 sheets be rolled per carton (480 x 480 mm).



□ WL OAK TREE Light

Photo: © iStock.com



PR+\*

**WL OAK TREE Light**  
2600 x 1000 / **NA** 17278 / **SA** 17279

## WOOD-LINE

# WL OAK TREE Light

2600 x 1000

### Product characteristics

	NA	SA
Base material	HIPS	
Surface material	impregnated paper	
Material thickness mm	1,2	1,33
Temperature stability	up to 60 °C	
Wet room suitability	■■■■□	
Abrasion resistance	■■■□□□	
Rolled packable **	✓	✓

### Processing

	NA	SA
Cutting, punching	✓	✓
Drilling	✓	✓
Sawing, milling	✓	—
Laser cutting	✓	✓
Hot bending	✓	—
Thermoforming	—	—
PVA compressible	✓	—
Smallest bending radius	150 mm	150 mm

### Extra equipment

	NA	SA
Special formats	On request	
Further thicknesses	✓	✓
Cuttings	✓	✓
Magnetic from 3 sheets	✓	
PVA pre-treatment	✓	—

### Accessories

SIBUKLE	Spatula A1
---------	------------

### Special colors

—
---

\* Prior to printing a corona or plasma treatment has to be carried out. Upon request available in pre-treated version.

\*\* Design sheets are to be rolled with the patterned side on the inside (applies for both the NA and SA versions). We recommend that not more than 3 sheets be rolled per carton (480 x 480 mm).





# DECO- LINE

SIBU | DESIGN



FR  
PR+

**DM OXIDIZED Autumn AR**  
2600 x 1000 / **NA** 20143 / **SA** 20191



FR  
PR+

**DM OXIDIZED Copper AR**  
2600 x 1000 / **NA** 20138 / **SA** 20186



FR  
PR+

**DM OXIDIZED Nickel AR**  
2600 x 1000 / **NA** 20140 / **SA** 20188



FR  
PR+

**DM OXIDIZED Platin AR**  
2600 x 1000 / **NA** 20141 / **SA** 20189



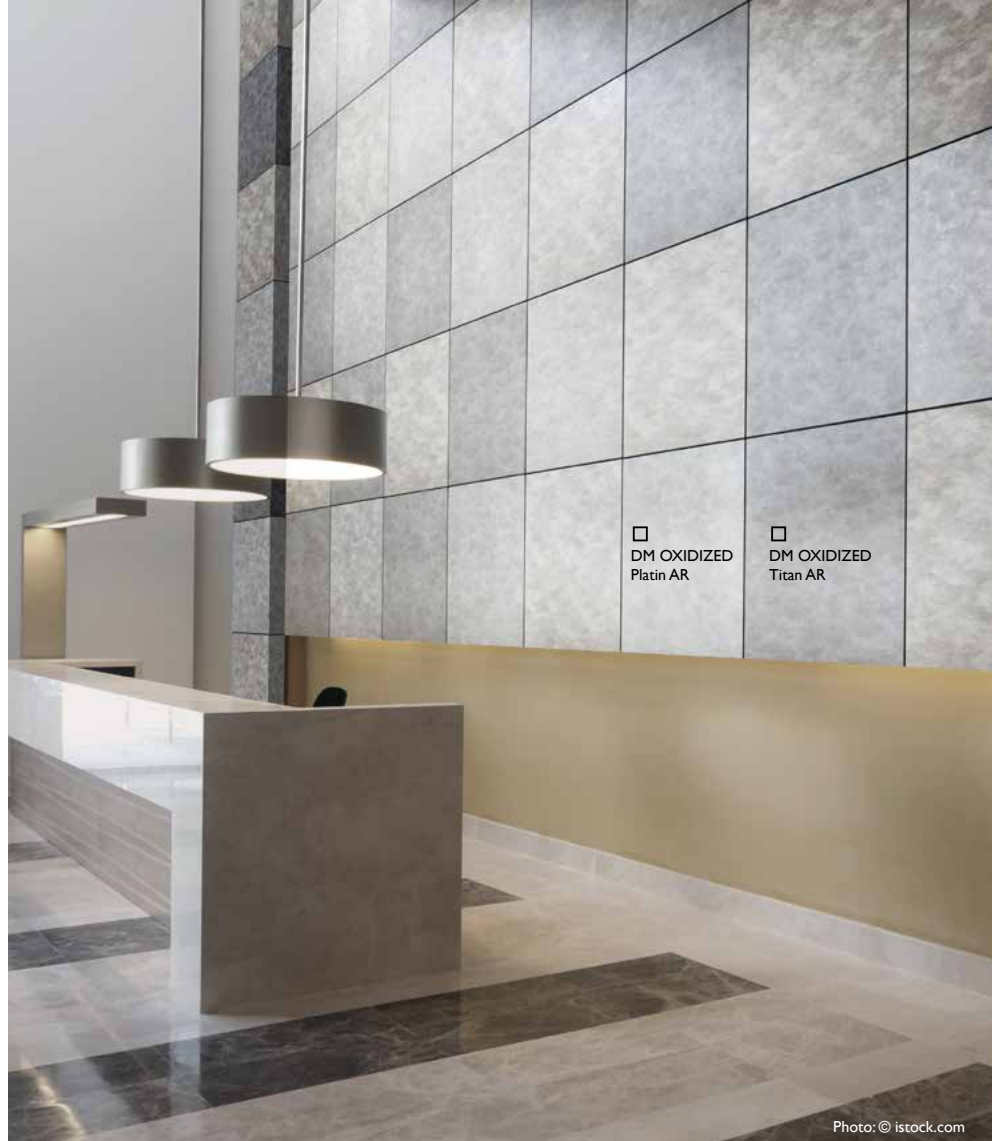
FR  
PR+

**DM OXIDIZED Titan AR**  
2600 x 1000 / **NA** 20142 / **SA** 20190

2600 x 1000



+ ▼



□ DM OXIDIZED Platin AR  
□ DM OXIDIZED Titan AR

Photo: © istock.com

DECO-LINE abrasion-resistant

# DM OXIDIZED AR

## Product characteristics

	NA	SA
Base material	HIPS	
Surface material	Print	
Material thickness mm	1,0	1,13
Temperature stability	up to 60 °C	
Wet room suitability	■■■□	
Abrasion resistance	■■■■■■■	
Rolled packable	✓	✓

## Processing

	NA	SA
Cutting, punching	✓	✓
Drilling	✓	✓
Sawing, milling	✓	—
Laser cutting	✓	✓
Hot bending	—	—
Thermoforming	—	—
PVA compressible	✓	—
Smallest bending radius	150 mm	

## Extra equipment

	NA	SA
Special formats	On request	
Further thicknesses	✓	✓
Cuttings	✓	✓
Magnetic from 3 sheets *	✓	
PVA pre-treatment	✓	—

\* Ground must be a SIBU metal foil SA (ref. 17637, self adhesive).

## Accessories

SIBUKLE	Spatula Al
---------	------------

## Special colors

—
---



Photo: © istock.com



FR

PR+

**DM SLIGHTLY USED Gold AR**  
2600 x 1000 / **NA** 20153 / **SA** 20201



FR

PR+

**DM SLIGHTLY USED Bronze AR**  
2600 x 1000 / **NA** 20152 / **SA** 20200



FR

PR+

**DM SLIGHTLY USED Copper AR**  
2600 x 1000 / **NA** 20151 / **SA** 20199



FR

PR+

**DM SLIGHTLY USED Titan AR**  
2600 x 1000 / **NA** 20154 / **SA** 20202

DECO-LINE abrasion-resistant

# DM SLIGHTLY USED AR

2600 x 1000



### Product characteristics

	NA	SA
Base material	HIPS	
Surface material	Print	
Material thickness mm	1,0	1,13
Temperature stability	up to 60 °C	
Wet room suitability	■■■■□	
Abrasion resistance	■■■■■■■	
Rolled packable	✓	✓

### Processing

	NA	SA
Cutting, punching	✓	✓
Drilling	✓	✓
Sawing, milling	✓	—
Laser cutting	✓	✓
Hot bending	—	—
Thermoforming	—	—
PVA compressible	✓	—
Smallest bending radius	150 mm	

### Extra equipment

	NA	SA
Special formats	On request	
Further thicknesses	✓	✓
Cuttings	✓	✓
Magnetic from 3 sheets *	✓	
PVA pre-treatment	✓	—

### Accessories

SIBUKLE	Spatula A1
---------	------------

### Special colors

—
---

\* Ground must be a SIBU metal foil SA (ref. 17637, self adhesive).





□ DM METALLIC USED Ivory AR



**DM METALLIC USED Ivory AR**  
2600 x 1000 / **NA** 20149 / **SA** 20197



**DM METALLIC USED Sand AR**  
2600 x 1000 / **NA** 20147 / **SA** 20195



**DM METALLIC USED Bronze AR**  
2600 x 1000 / **NA** 20146 / **SA** 20194



**DM METALLIC USED Steel AR**  
2600 x 1000 / **NA** 20148 / **SA** 20196

DECO-LINE abrasion-resistant

# DM METALLIC USED AR

## Product characteristics

	NA	SA
Base material	HIPS	
Surface material	Print	
Material thickness mm	1,0	1,13
Temperature stability	up to 60 °C	
Wet room suitability	■■■■□	
Abrasion resistance	■■■■■■■	
Rolled packable	✓	✓

## Processing

	NA	SA
Cutting, punching	✓	✓
Drilling	✓	✓
Sawing, milling	✓	—
Laser cutting	✓	✓
Hot bending	—	—
Thermoforming	—	—
PVA compressible	✓	—
Smallest bending radius	150 mm	

## Extra equipment

	NA	SA
Special formats	On request	
Further thicknesses	✓	✓
Cuttings	✓	✓
Magnetic from 3 sheets *	✓	
PVA pre-treatment	✓	—

## Accessories

SIBUKLE	Spatula A1
---------	------------

## Special colors

—
---

\* Ground must be a SIBU metal foil SA (ref. 17637, self adhesive).

2600 x 1000

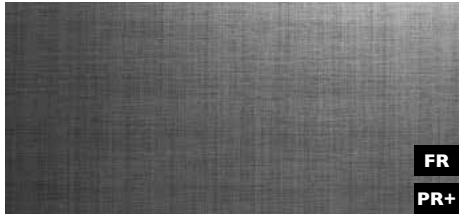






FR  
PR+

**DM REFINED METAL Silver AR**  
2600 x 1000 / **NA** 20155 / **SA** 20203



FR  
PR+

**DM REFINED METAL Titan AR**  
2600 x 1000 / **NA** 20156 / **SA** 20204

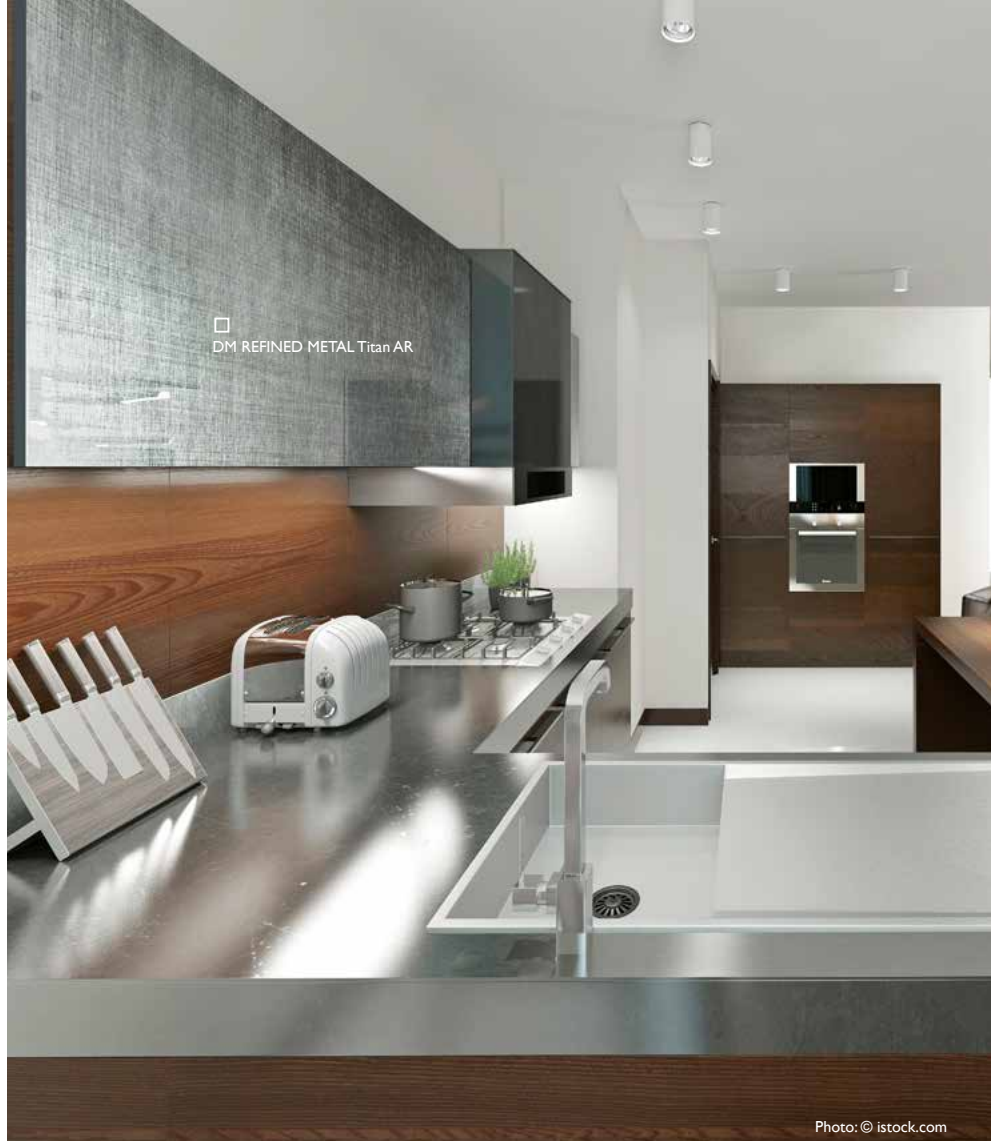
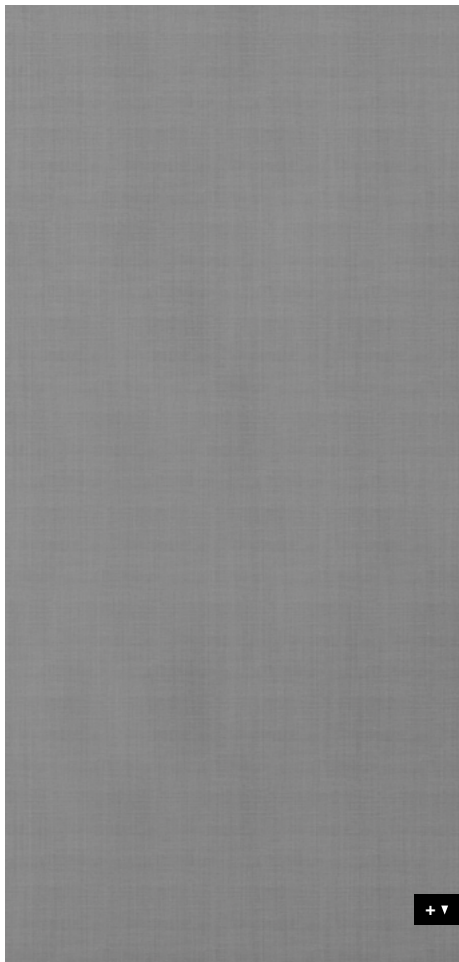


Photo: © istock.com

2600 x 1000



DECO-LINE abrasion-resistant

# DM REFINED METAL AR

## Product characteristics

	NA	SA
Base material	HIPS	
Surface material	Print	
Material thickness mm	1,0	1,13
Temperature stability	up to 60 °C	
Wet room suitability	■■■■□	
Abrasion resistance	■■■■■■■	
Rolled packable	✓	✓

## Processing

	NA	SA
Cutting, punching	✓	✓
Drilling	✓	✓
Sawing, milling	✓	—
Laser cutting	✓	✓
Hot bending	—	—
Thermoforming	—	—
PVA compressible	✓	—
Smallest bending radius	150 mm	

## Extra equipment

	NA	SA
Special formats	On request	
Further thicknesses	✓	✓
Cuttings	✓	✓
Magnetic from 3 sheets *	✓	
PVA pre-treatment	✓	—

\* Ground must be a SIBU metal foil SA (ref. 17637, self adhesive).

## Accessories

SIBUKLE	Spatula Al
---------	------------

## Special colors

—
---

+ ▼





Photo: © istock.com



FR

PR+

**DM METALLIC USED Champagne AR**  
2600 x 1000 / **NA** 20150 / **SA** 20198



FR

PR+

**DM METALLIC USED Titan AR**  
2600 x 1000 / **NA** 20144 / **SA** 20192

DECO-LINE abrasion-resistant

# DM METALLIC USED AR

2600 x 1000



## Product characteristics

	NA	SA
Base material	HIPS	
Surface material	Print	
Material thickness mm	1,0	1,13
Temperature stability	up to 60 °C	
Wet room suitability	■■■■□	
Abrasion resistance	■■■■■■■	
Rolled packable	✓	✓

## Processing

	NA	SA
Cutting, punching	✓	✓
Drilling	✓	✓
Sawing, milling	✓	—
Laser cutting	✓	✓
Hot bending	—	—
Thermoforming	—	—
PVA compressible	✓	—
Smallest bending radius	150 mm	

## Extra equipment

	NA	SA
Special formats	On request	
Further thicknesses	✓	✓
Cuttings	✓	✓
Magnetic from 3 sheets *	✓	
PVA pre-treatment	✓	—

\* Ground must be a SIBU metal foil SA (ref. 17637, self adhesive).

## Accessories

SIBUKLE	Spatula A I
---------	-------------

## Special colors

—
---



FR  
PR+

**DM Iron Age AR**  
2600 x 1000 / **NA** 19201 / **SA** 19209



□  
DM Iron Age AR

Photo: © fotolia.com

2600 x 1000



DECO-LINE abrasion-resistant

# DM Iron Age AR

## Product characteristics

	NA	SA
Base material	HIPS	
Surface material	Print	
Material thickness mm	1,0	1,13
Temperature stability	up to 60 °C	
Wet room suitability	■■■□	
Abrasion resistance	■■■■■■■	
Rolled packable	✓	✓

## Processing

	NA	SA
Cutting, punching	✓	✓
Drilling	✓	✓
Sawing, milling	✓	—
Laser cutting	✓	✓
Hot bending	—	—
Thermoforming	—	—
PVA compressible	✓	—
Smallest bending radius	150 mm	150 mm

## Extra equipment

	NA	SA
Special formats	On request	
Further thicknesses	✓	✓
Cuttings	✓	✓
Magnetic from 3 sheets *	✓	
PVA pre-treatment	✓	—

## Accessories

SIBUKLE	Spatula AI
---------	------------

## Special colors

—
---

\* Ground must be a SIBU metal foil SA (ref. 17637, self adhesive).





□ DM CLASSY Silver AR

Photo: © fotolia.com



**DM CLASSY Silver AR**  
2600 x 1000 / **NA** 19326 / **SA** 19337



**DM CLASSY Bronze AR**  
2600 x 1000 / **NA** 19011 / **SA** 19022



**DM CLASSY Copper AR**  
2600 x 1000 / **NA** 19199 / **SA** 19207



**DM CLASSY Gold AR**  
2600 x 1000 / **NA** 19010 / **SA** 19021



**DM CLASSY Black AR**  
2600 x 1000 / **NA** 19325 / **SA** 19336



## DECO-LINE abrasion-resistant

# DM CLASSY AR

### Product characteristics

	NA	SA
Base material	HIPS	
Surface material	Print	
Material thickness mm	1,0	1,13
Temperature stability	up to 60 °C	
Wet room suitability	■■■■□	
Abrasion resistance	■■■■■■■	
Rolled packable	✓	✓

### Processing

	NA	SA
Cutting, punching	✓	✓
Drilling	✓	✓
Sawing, milling	✓	—
Laser cutting	✓	✓
Hot bending	—	—
Thermoforming	—	—
PVA compressible	✓	—
Smallest bending radius	150 mm	150 mm

### Extra equipment

	NA	SA
Special formats	On request	
Further thicknesses	✓	✓
Cuttings	✓	✓
Magnetic from 3 sheets *	✓	
PVA pre-treatment	✓	—

### Accessories

SIBUKLE	Spatula A1
---------	------------

### Special colors

—
---

\* Ground must be a SIBU metal foil SA (ref. 17637, self adhesive).





FR  
PR+

**DM LUXURY Bronze AR**  
2600 x 1000 / **NA** 21487 / **SA** 21488



FR  
PR+

**DM LUXURY Gold AR**  
2600 x 1000 / **NA** 21391 / **SA** 21392



□  
DM LUXURY Bronze AR

2600 x 1000



+ ▼

## DECO-LINE

# DM LUXURY AR

### Product characteristics

	NA	SA
Base material	HIPS	
Surface material	Print	
Material thickness mm	1,0	1,13
Temperature stability	up to 60 °C	
Wet room suitability	■■■□	
Abrasion resistance	■■■■■■■	
Rolled packable	✓	✓

### Processing

	NA	SA
Cutting, punching	✓	✓
Drilling	✓	✓
Sawing, milling	✓	—
Laser cutting	✓	✓
Hot bending	—	—
Thermoforming	—	—
PVA compressible	✓	—
Smallest bending radius	150 mm	150 mm

### Extra equipment

	NA	SA
Special formats	On request	
Further thicknesses	✓	✓
Cuttings	✓	✓
Magnetic from 3 sheets	✓	
PVA pre-treatment	✓	—

### Accessories

SIBUKLE	Spatula A1
---------	------------

### Special colors

—
---



□ DM VINTAGE Copper



FR  
PR+

**DM VINTAGE Copper**  
2600 x 1000 / NA 17276 / SA 17277



FR  
PR+

**DM VINTAGE Silver**  
2600 x 1000 / NA 17274 / SA 17275

## DECO-LINE

# DM Vintage

2600 x 1000

### Product characteristics

	NA	SA
Base material	HIPS	
Surface material	Print	
Material thickness mm	1,0	1,13
Temperature stability	up to 60 °C	
Wet room suitability	■■■■□	
Abrasion resistance	■■■■■□	
Rolled packable	✓	✓

### Processing

	NA	SA
Cutting, punching	✓	✓
Drilling	✓	✓
Sawing, milling	✓	—
Laser cutting	✓	✓
Hot bending	✓	—
Thermoforming	✓	—
PVA compressible	✓	—
Smallest bending radius	150 mm	150 mm

### Extra equipment

	NA	SA
Special formats	On request	
Further thicknesses	✓	✓
Cuttings	✓	✓
Magnetic from 3 sheets	✓	
PVA pre-treatment	✓	—

### Accessories

SIBUKLE	Spatula A1
---------	------------

### Special colors

—
---







PR+

**DM CONCRETE Grey**  
2600 x 1000 / **NA** 22827 / **SA** 22828



□  
DM CONCRETE Grey

Photo: © iStock.com

2600 x 1000



DECO-LINE

# DM CONCRET Grey

## Product characteristics

	NA	SA
Base material	HIPS	
Surface material	PP	
Material thickness mm	1,3	1,43
Temperature stability	up to 60 °C	
Wet room suitability	■■■□	
Abrasion resistance	■■■■■■■	
Rolled packable **	✓	✓

## Processing

	NA	SA
Cutting, punching	✓	✓
Drilling	✓	✓
Sawing, milling	✓	—
Laser cutting	✓	✓
Hot bending	✓	—
Thermoforming	—	—
PVA compressible	✓	—
Smallest bending radius	150 mm	150 mm

## Extra equipment

	NA	SA
Special formats	On request	
Further thicknesses	✓	✓
Cuttings	✓	✓
Magnetic from 3 sheets ***	✓	
PVA pre-treatment	✓	—

## Accessories

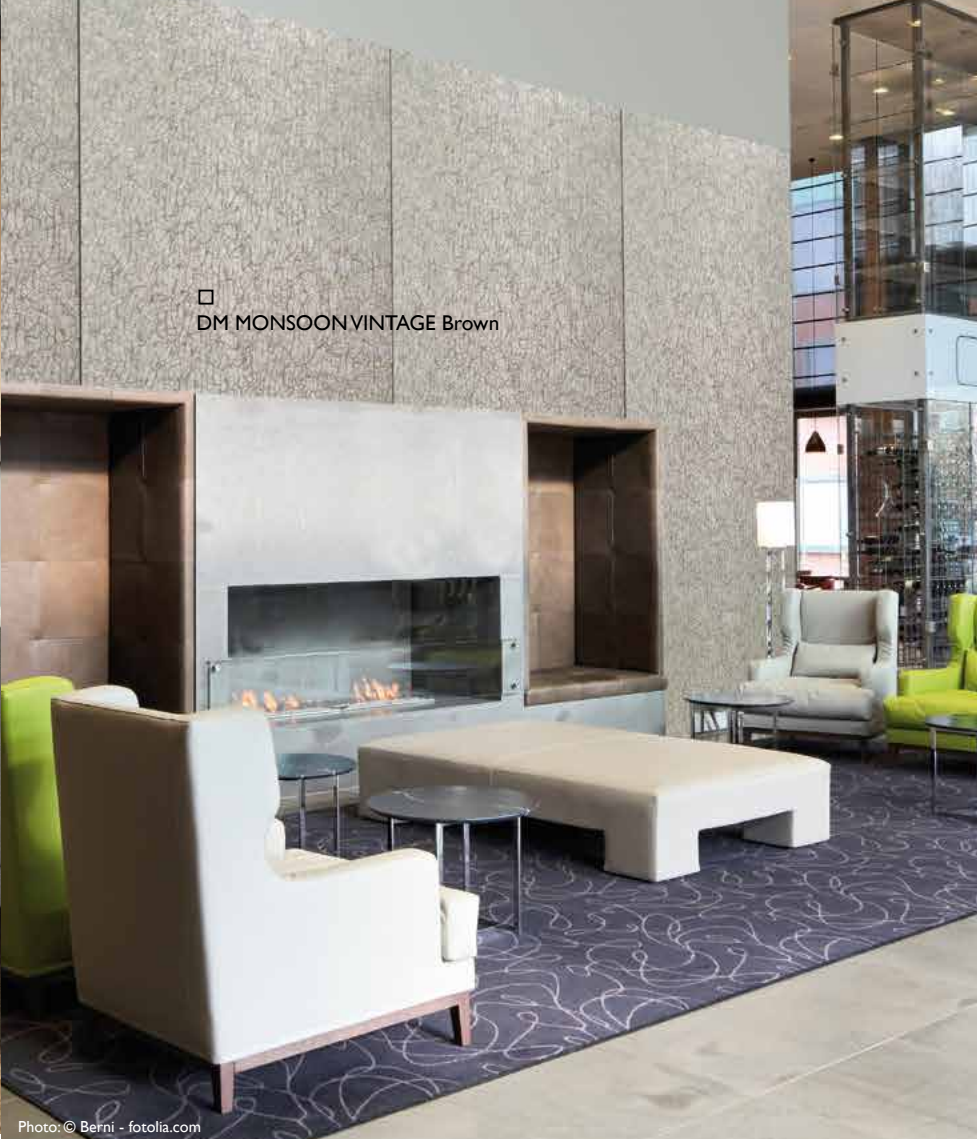
SIBUKLE	Spatula A1
---------	------------

## Special colors

—
---

+ ▼





□  
DM MONSOON VINTAGE Brown



PRS

**DM MONSOON VINTAGE Brown**  
2600 x 1000 / **NA** 17033 / **SA** 17037

Photo: © Berni - fotolia.com

## DECO-LINE

# DM MONSOON

2600 x 1000

### Product characteristics

	NA	SA
Base material	HIPS	
Surface material	Print	
Material thickness mm	1,0	1,13
Temperature stability	up to 60 °C	
Wet room suitability	■■■□	
Abrasion resistance	■■■□□□	
Rolled packable	✓	✓

### Processing

	NA	SA
Cutting, punching	✓	✓
Drilling	✓	✓
Sawing, milling	✓	—
Laser cutting	✓	✓
Hot bending	✓	—
Thermoforming	—	—
PVA compressible	✓	—
Smallest bending radius	150 mm	150 mm

### Extra equipment

	NA	SA
Special formats	On request	
Further thicknesses	—	—
Cuttings	✓	✓
Magnetic from 3 sheets	✓	
PVA pre-treatment	✓	—

### Accessories

SIBUKLE	Spatula A1
---------	------------

### Special colors

—
---





PR+\*

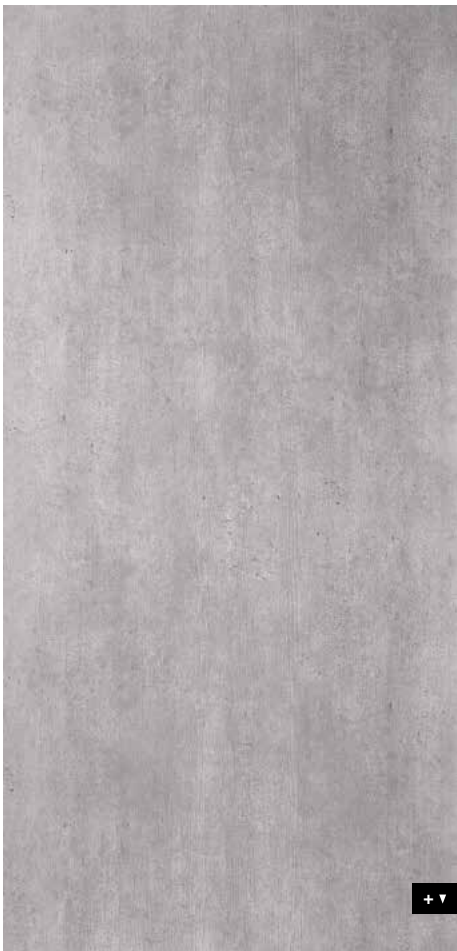
**DM CEMENT Light**

2600 x 1000 / **NA** 19087 / **SA** 19091



□ DM CEMENT Light

2600 x 1000



DECO-LINE

**DM CEMENT Light**

**Product characteristics**

	NA	SA
Base material	HIPS	
Surface material	impregnated paper	
Material thickness mm	1,2	1,33
Temperature stability	up to 60 °C	
Wet room suitability	■■■■□	
Abrasion resistance	■■■■■□	
Rolled packable **	✓	✓

**Processing**

	NA	SA
Cutting, punching	✓	✓
Drilling	✓	✓
Sawing, milling	✓	—
Laser cutting	✓	✓
Hot bending	✓	—
Thermoforming	—	—
PVA compressible	✓	—
Smallest bending radius	150 mm	150 mm

**Extra equipment**

	NA	SA
Special formats	On request	
Further thicknesses	✓	✓
Cuttings	✓	✓
Magnetic from 3 sheets ***	✓	
PVA pre-treatment	✓	—

**Accessories**

SIBUKLE	Spatula A1
---------	------------

**Special colors**

—
---

\* Prior to printing a corona or plasma treatment has to be carried out. Upon request available in pre-treated version.  
 \*\* Design sheets are to be rolled with the patterned side on the inside (applies for both the NA and SA versions).  
 We recommend that not more than 3 sheets be rolled per carton (480 x 480 mm).  
 \*\*\* Ground must be a SIBU metal foil SA (ref. 17637, self adhesive).







**DM CEMENT Dark**  
2600 x 1000 / **NA** 19088 / **SA** 19092

## DECO-LINE

# DM CEMENT Dark

2600 x 1000



### Product characteristics

	NA	SA
Base material	HIPS	
Surface material	impregnated paper	
Material thickness mm	1,3	1,43
Temperature stability	up to 60 °C	
Wet room suitability	■■■■□	
Abrasion resistance	■■■■□□	
Rolled packable **	✓	✓

### Processing

	NA	SA
Cutting, punching	✓	✓
Drilling	✓	✓
Sawing, milling	✓	—
Laser cutting	✓	✓
Hot bending	✓	—
Thermoforming	—	—
PVA compressible	✓	—
Smallest bending radius	150 mm	150 mm

### Extra equipment

	NA	SA
Special formats	On request	
Further thicknesses	✓	✓
Cuttings	✓	✓
Magnetic from 3 sheets ***	✓	
PVA pre-treatment	✓	—

### Accessories

SIBUKLE	Spatula A1
---------	------------

### Special colors

—
---

\* Prior to printing a corona or plasma treatment has to be carried out. Upon request available in pre-treated version.  
 \*\* Design sheets are to be rolled with the patterned side on the inside (applies for both the NA and SA versions).  
 \*\*\* We recommend that not more than 3 sheets be rolled per carton (480 x 480 mm).  
 \*\*\*\* Ground must be a SIBU metal foil SA (ref. 17637, self adhesive).





PR+\*

**DM MARBLE White**  
2600 x 1000 / **NA** 19327 / **SA** 19338



□  
DM MARBLE White

Photo: © fotolia.com

2600 x 1000



DECO-LINE

# DM MARBLE White

## Product characteristics

	NA	SA
Base material	HIPS	
Surface material	impregnated paper	
Material thickness mm	1,3	1,43
Temperature stability	up to 60 °C	
Wet room suitability	■■■□	
Abrasion resistance	■■■■■□	
Rolled packable **	✓	✓

## Processing

	NA	SA
Cutting, punching	✓	✓
Drilling	✓	✓
Sawing, milling	✓	—
Laser cutting	✓	✓
Hot bending	✓	—
Thermoforming	—	—
PVA compressible	✓	—
Smallest bending radius	150 mm	150 mm

## Extra equipment

	NA	SA
Special formats	On request	
Further thicknesses	✓	✓
Cuttings	✓	✓
Magnetic from 3 sheets ***	✓	
PVA pre-treatment	✓	—

## Accessories

SIBUKLE	Spatula Al
---------	------------

## Special colors

—
---

\* Prior to printing a corona or plasma treatment has to be carried out. Upon request available in pre-treated version.  
\*\* Design sheets are to be rolled with the patterned side on the inside (applies for both the NA and SA versions).  
We recommend that not more than 3 sheets be rolled per carton (480 x 480 mm).  
\*\*\* Ground must be a SIBU metal foil SA (ref. 17637; self adhesive).





□  
DM Travertin



PRS\*

**DM Travertin**  
2600 x 1000 / **NA** 19328 / **SA** 19339

## DECO-LINE

# DM Travertin

2600 x 1000



### Product characteristics

	NA	SA
Base material	HIPS	
Surface material	impregnated paper	
Material thickness mm	1,3	1,43
Temperature stability	up to 60 °C	
Wet room suitability	■■■■□	
Abrasion resistance	■■■■□□	
Rolled packable **	✓	✓

### Processing

	NA	SA
Cutting, punching	✓	✓
Drilling	✓	✓
Sawing, milling	✓	—
Laser cutting	✓	✓
Hot bending	✓	—
Thermoforming	—	—
PVA compressible	✓	—
Smallest bending radius	150 mm	150 mm

### Extra equipment

	NA	SA
Special formats	On request	
Further thicknesses	✓	✓
Cuttings	✓	✓
Magnetic from 3 sheets***	✓	
PVA pre-treatment	✓	—

### Accessories

SIBUKLE	Spatula A I
---------	-------------

### Special colors

—
---

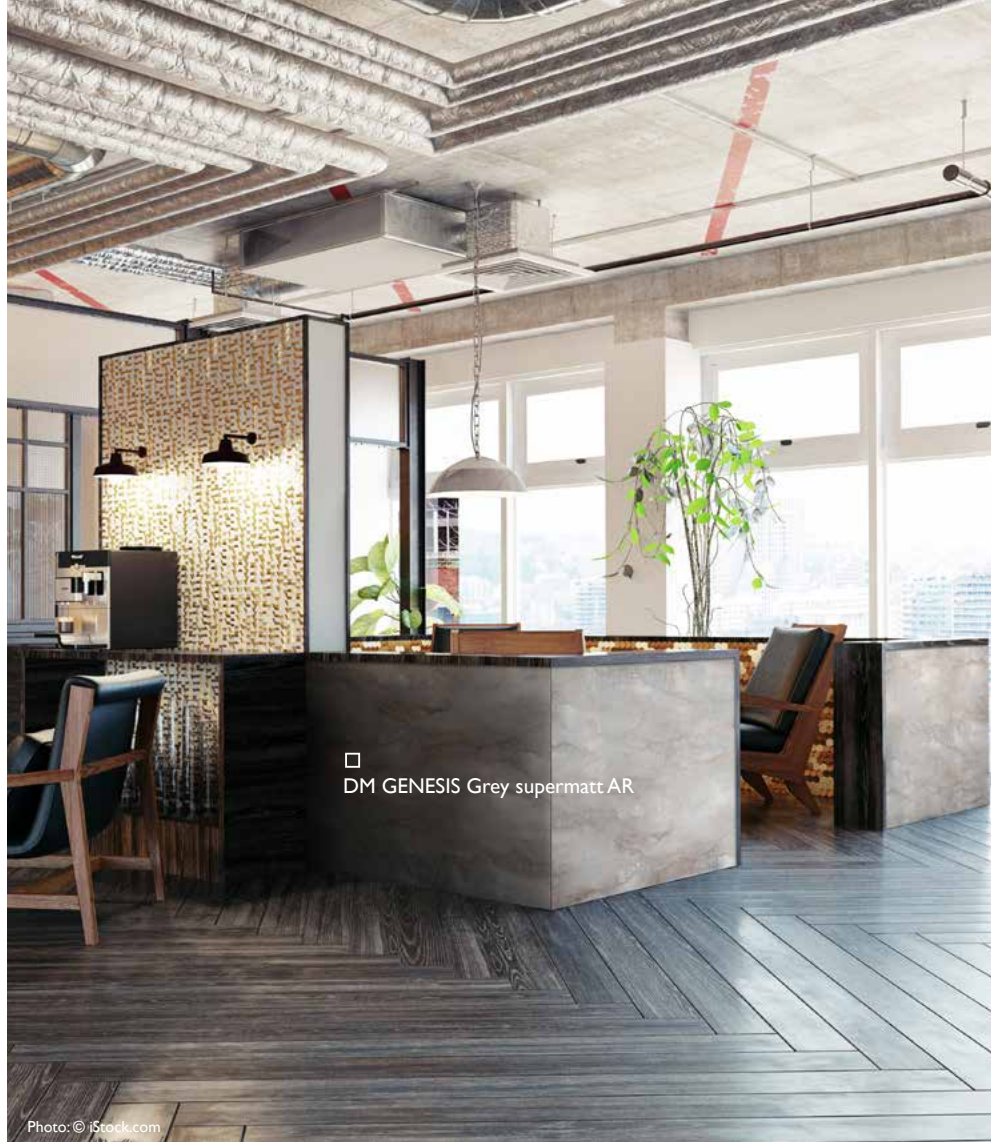
\* Prior to printing a corona or plasma treatment has to be carried out. Upon request available in pre-treated version.  
\*\* Design sheets are to be rolled with the patterned side on the inside (applies for both the NA and SA versions).  
\*\*\* We recommend that not more than 3 sheets be rolled per carton (480 x 480 mm).  
\*\*\*\* Ground must be a SIBU metal foil SA (ref. 17637, self adhesive).





PRS\*

**DM GENESIS Grey supermatt AR**  
2600 x 1000 / **NA** 23093 / **SA** 23101



□  
DM GENESIS Grey supermatt AR

Photo: © iStock.com

2600 x 1000



## DECO-LINE

# DM GENESIS Grey supermatt AR

### Product characteristics

	NA	SA
Base material	HIPS	
Surface material	PET	
Material thickness mm	1,4	1,53
Temperature stability	up to 60 °C	
Wet room suitability	■■■■□	
Abrasion resistance	■■■■■■□	
Rolled packable **	✓	✓

### Processing

	NA	SA
Cutting, punching	✓	✓
Drilling	✓	✓
Sawing, milling	✓	—
Laser cutting	✓	✓
Hot bending	✓	—
Thermoforming	—	—
PVA compressible	✓	—
Smallest bending radius	150 mm	

### Extra equipment

	NA	SA
Special formats	On request	
Further thicknesses	✓	✓
Cuttings	✓	✓
Magnetic from 3 sheets ***	✓	
PVA pre-treatment	✓	—

### Accessories

SIBUKLE	Spatula A1
---------	------------

### Special colors

—
---





PRS\*

**DM GENESIS White supermatt AR**  
2600 x 1000 / **NA** 23092 / **SA** 23100

Photo: © iStock.com

## DECO-LINE

# DM GENESIS White supermatt AR

2600 x 1000



### Product characteristics

	NA	SA
Base material	HIPS	
Surface material	PET	
Material thickness mm	1,4	1,53
Temperature stability	up to 60 °C	
Wet room suitability	■■■■□	
Abrasion resistance	■■■■■□	
Rolled packable **	✓	✓

### Processing

	NA	SA
Cutting, punching	✓	✓
Drilling	✓	✓
Sawing, milling	✓	—
Laser cutting	✓	✓
Hot bending	✓	—
Thermoforming	—	—
PVA compressible	✓	—
Smallest bending radius	150 mm	

### Extra equipment

	NA	SA
Special formats	On request	
Further thicknesses	✓	✓
Cuttings	✓	✓
Magnetic from 3 sheets ***	✓	
PVA pre-treatment	✓	—

### Accessories

SIBUKLE	Spatula A1
---------	------------

### Special colors

—
---

\* Prior to printing a corona or plasma treatment has to be carried out. Upon request available in pre-treated version.  
\*\* Design sheets are to be rolled with the patterned side on the inside (applies for both the NA and SA versions).  
\*\*\* We recommend that not more than 3 sheets be rolled per carton (480 x 480 mm).  
\*\*\*\* Ground must be a SIBU metal foil SA (ref. 17637, self adhesive).





PRS\*

**DM MARBLE White supermatt AR**  
2600 x 1000 / **NA** 23091 / **SA** 23098



□ DM MARBLE White supermatt AR

Photo: © iStock.com

2600 x 1000



## DECO-LINE

# DM MARBLE White supermatt AR

### Product characteristics

	NA	SA
Base material	HIPS	
Surface material	PET	
Material thickness mm	1,4	1,53
Temperature stability	up to 60 °C	
Wet room suitability	■■■■□	
Abrasion resistance	■■■■■■□	
Rolled packable **	✓	✓

### Processing

	NA	SA
Cutting, punching	✓	✓
Drilling	✓	✓
Sawing, milling	✓	—
Laser cutting	✓	✓
Hot bending	✓	—
Thermoforming	—	—
PVA compressible	✓	—
Smallest bending radius	150 mm	

### Extra equipment

	NA	SA
Special formats	On request	
Further thicknesses	✓	✓
Cuttings	✓	✓
Magnetic from 3 sheets ***	✓	
PVA pre-treatment	✓	—

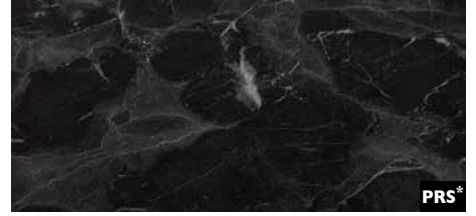
### Accessories

SIBUKLE	Spatula A1
---------	------------

### Special colors

—
---





**DM MARBLE Black supermatt AR**  
2600 x 1000 / **NA** 22947 / **SA** 23099

Photo: © iStock.com

## DECO-LINE

# DM MARBLE Black supermatt AR

2600 x 1000

### Product characteristics

	NA	SA
Base material	HIPS	
Surface material	PET	
Material thickness mm	1,4	1,53
Temperature stability	up to 60 °C	
Wet room suitability	■■■■□	
Abrasion resistance	■■■■□□	
Rolled packable **	✓	✓

### Processing

	NA	SA
Cutting, punching	✓	✓
Drilling	✓	✓
Sawing, milling	✓	—
Laser cutting	✓	✓
Hot bending	✓	—
Thermoforming	—	—
PVA compressible	✓	—
Smallest bending radius	150 mm	

### Extra equipment

	NA	SA
Special formats	On request	
Further thicknesses	✓	✓
Cuttings	✓	✓
Magnetic from 3 sheets ***	✓	
PVA pre-treatment	✓	—

### Accessories

SIBUKLE	Spatula A I
---------	-------------

### Special colors

—
---

\* Prior to printing a corona or plasma treatment has to be carried out. Upon request available in pre-treated version.  
\*\* Design sheets are to be rolled with the patterned side on the inside (applies for both the NA and SA versions).  
\*\*\* We recommend that not more than 3 sheets be rolled per carton (480 x 480 mm).  
\*\*\*\* Ground must be a SIBU metal foil SA (ref. 17637, self adhesive).





**DM Magic White AR**

2600 x 1000 / 1 mm / **NA** 15414 / **SA** 15422



**DM Magic Black AR**

2600 x 1000 / 1 mm / **NA** 15415 / **SA** 15423  
 2600 x 1000 / 2 mm / **NA** 15417 / **SA** -



Photo: SU VALGUS

DECO-LINE abrasion-resistant

# DM Magic AR

**Product characteristics**

	NA	SA
Base material	HIPS	
Surface material	PET	
Material thickness mm	1,0 / 2,0	1,13 / 2,13
Temperature stability	up to 60 °C	
Wet room suitability	■■■■■	
Abrasion resistance	■■■■■■■	
Rolled packable	✓	✓

**Processing**

	NA	SA
Cutting, punching	✓	✓
Drilling	✓	✓
Sawing, milling	✓	—
Laser cutting	✓	✓
Hot bending	✓	—
Thermoforming	✓	—
PVA compressible	✓	—
Smallest bending radius	150 mm	

**Extra equipment**

	NA	SA
Special formats	On request	
Further thicknesses	✓	✓
Cuttings	✓	✓
Magnetic from 3 sheets	✓	
PVA pre-treatment	✓	—

**Accessories**

SIBUKLE	Spatula A1
---------	------------

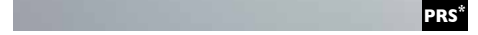
**Special colors**

On request
------------

□ DM Graphit Black matt AR



Photo: Fotolia.com



**DM Snow White matt AR**  
2600 x 1000 / **NA** 23145 / **SA** 23146



**DM Graphite Black matt AR**  
2600 x 1000 / **NA** 23144 / **SA** 23147

DECO-LINE abrasion-resistant

# DM matt AR

## Product characteristics

	NA	SA
Base material	HIPS	
Surface material	PET	
Material thickness mm	1,0	1,13
Temperature stability	up to 60 °C	
Wet room suitability	■■■■■	
Abrasion resistance	■■■■■□	
Rolled packable	✓	✓

## Processing

	NA	SA
Cutting, punching	✓	✓
Drilling	✓	✓
Sawing, milling	✓	—
Laser cutting	✓	✓
Hot bending	✓	—
Thermoforming	✓	—
PVA compressible	✓	—
Smallest bending radius	150 mm	

## Extra equipment

	NA	SA
Special formats	On request	
Further thicknesses	✓	✓
Cuttings	✓	✓
Magnetic from 3 sheets	✓	
PVA pre-treatment	✓	—

## Accessories

SIBUKLE	Spatula A I
---------	-------------

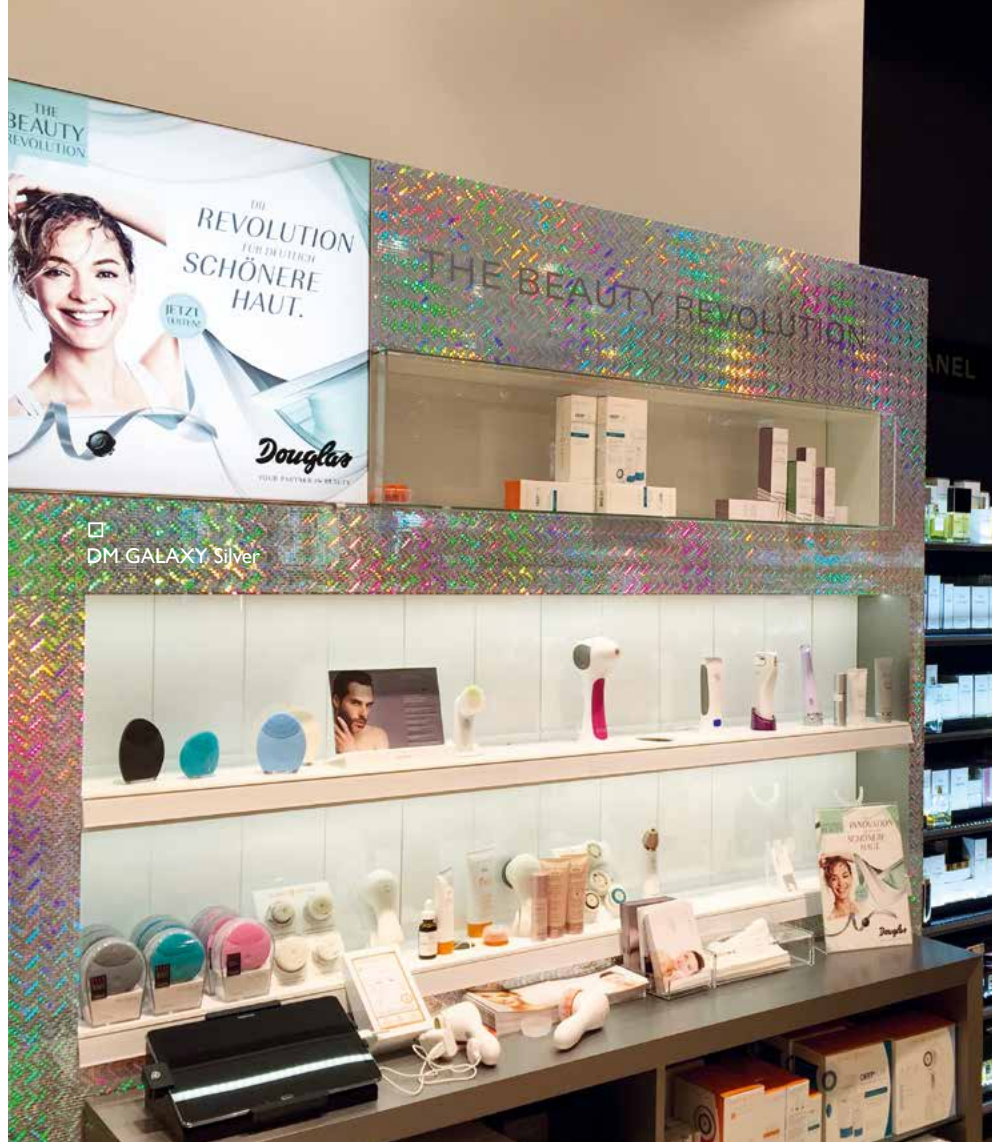
## Special colors

On request
------------

\* Prior to printing a corona or plasma treatment has to be carried out. Upon request available in pre-treated version.

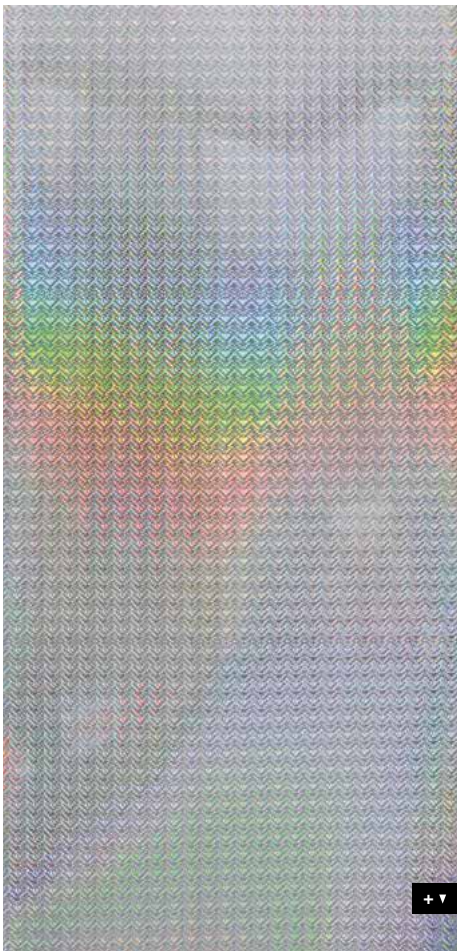


**DM GALAXY Silver**  
2600 x 1000 / **NA** 10169 / **SA** 10175



DM GALAXY Silver

2600 x 1000



## DECO-LINE

# DM GALAXY

### Product characteristics

	NA	SA
Base material	HIPS	
Surface material	Print	
Material thickness mm	1,0	1,13
Temperature stability	up to 60 °C	
Wet room suitability	■■■■□	
Abrasion resistance	■■■■■■□	
Rolled packable	✓	✓

### Processing

	NA	SA
Cutting, punching	✓	✓
Drilling	✓	✓
Sawing, milling	✓	—
Laser cutting	✓	✓
Hot bending	✓	—
Thermoforming	—	—
PVA compressible	✓	—
Smallest bending radius	150 mm	

### Extra equipment

	NA	SA
Special formats	On request	
Further thicknesses	✓	✓
Cuttings	✓	✓
Magnetic from 3 sheets	✓	
PVA pre-treatment	✓	—

### Accessories

SIBUKLE	Spatula A1
---------	------------

### Special colors

—
---





**DM Hollywood**  
2600 x 1000 / **NA** 18433 / **SA** 18442



**DM Hollywood Blue**  
2600 x 1000 / **NA** 20945 / **SA** 21272



**DM Aqua**  
2600 x 1000 / **NA** 18424 / **SA** 18443

## DECO-LINE

# DM Mirror

### Product characteristics

	NA	SA
Base material	HIPS	
Surface material	PET	
Material thickness mm	1,0	1,13
Temperature stability	up to 60 °C	
Wet room suitability	■■■■□	
Abrasion resistance	■■■■□□	
Rolled packable	✓	✓

### Processing

	NA	SA
Cutting, punching	✓	✓
Drilling	✓	✓
Sawing, milling	✓	—
Laser cutting	✓	✓
Hot bending	✓	—
Thermoforming	✓	—
PVA compressible	✓	—
Smallest bending radius	150 mm	

### Extra equipment

	NA	SA
Special formats	On request	
Further thicknesses	✓	✓
Cuttings	✓	✓
Magnetic from 3 sheets	✓	
PVA pre-treatment	✓	—

### Accessories

SIBUKLE	Spatula A1
---------	------------

### Special colors

On request
------------



**DM LUXURY Holografico**  
2600 x 1000 / **NA** 19009 / **SA** 19020

PR+



DM LUXURY Holografico

Photo: © istock.com

2600 x 1000



+ ▼

## DECO-LINE

# DM LUXURY Holografico

### Product characteristics

	NA	SA
Base material	HIPS	
Surface material	Print	
Material thickness mm	1,0	1,13
Temperature stability	up to 60 °C	
Wet room suitability	■■■□	
Abrasion resistance	■□□□□□	
Rolled packable	✓	✓

### Processing

	NA	SA
Cutting, punching	✓	✓
Drilling	✓	✓
Sawing, milling	✓	—
Laser cutting	✓	✓
Hot bending	✓	—
Thermoforming	—	—
PVA compressible	✓	—
Smallest bending radius	150 mm	

### Extra equipment

	NA	SA
Special formats	On request	
Further thicknesses	✓	✓
Cuttings	✓	✓
Magnetic from 3 sheets *	✓	
PVA pre-treatment	✓	—

\* Ground must be a SIBU metal foil SA (ref. 17637, self adhesive).

### Accessories

SIBUKLE	Spatula A1
---------	------------

### Special colors

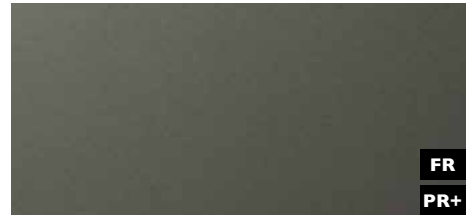
—
---



□ DM Smoke PF



**DM Silver PF**  
2600 x 1000 / **NA** 10357 / **SA** 10363



**DM Smoke PF**  
2600 x 1000 / **NA** 10385 / **SA** 10389

DECO-LINE abrasion-resistant

# DM PF

### Product characteristics

	NA	SA
Base material	HIPS	
Surface material	Print	
Material thickness mm	1,0	1,13
Temperature stability	up to 60 °C	
Wet room suitability	■■■■■	
Abrasion resistance	■■■■■■■	
Rolled packable	✓	✓

### Processing

	NA	SA
Cutting, punching	✓	✓
Drilling	✓	✓
Sawing, milling	✓	—
Laser cutting	✓	✓
Hot bending	✓	—
Thermoforming	✓	—
PVA compressible	✓	—
Smallest bending radius	150 mm	

### Extra equipment

	NA	SA
Special formats	On request	
Further thicknesses	✓	✓
Cuttings	✓	✓
Magnetic from 3 sheets	✓	
PVA pre-treatment	✓	—

### Accessories

SIBUKLE	Spatula A1
---------	------------

### Special colors

On request
------------





**DM OPTICAL MIRROR Silver AR**  
2800 x 1250 / NA 20877



**DM OPTICAL MIRROR Fashion Grey AR**  
2800 x 1250 / NA 21244



**DM OPTICAL MIRROR Anthracite AR**  
2800 x 1250 / NA 21241



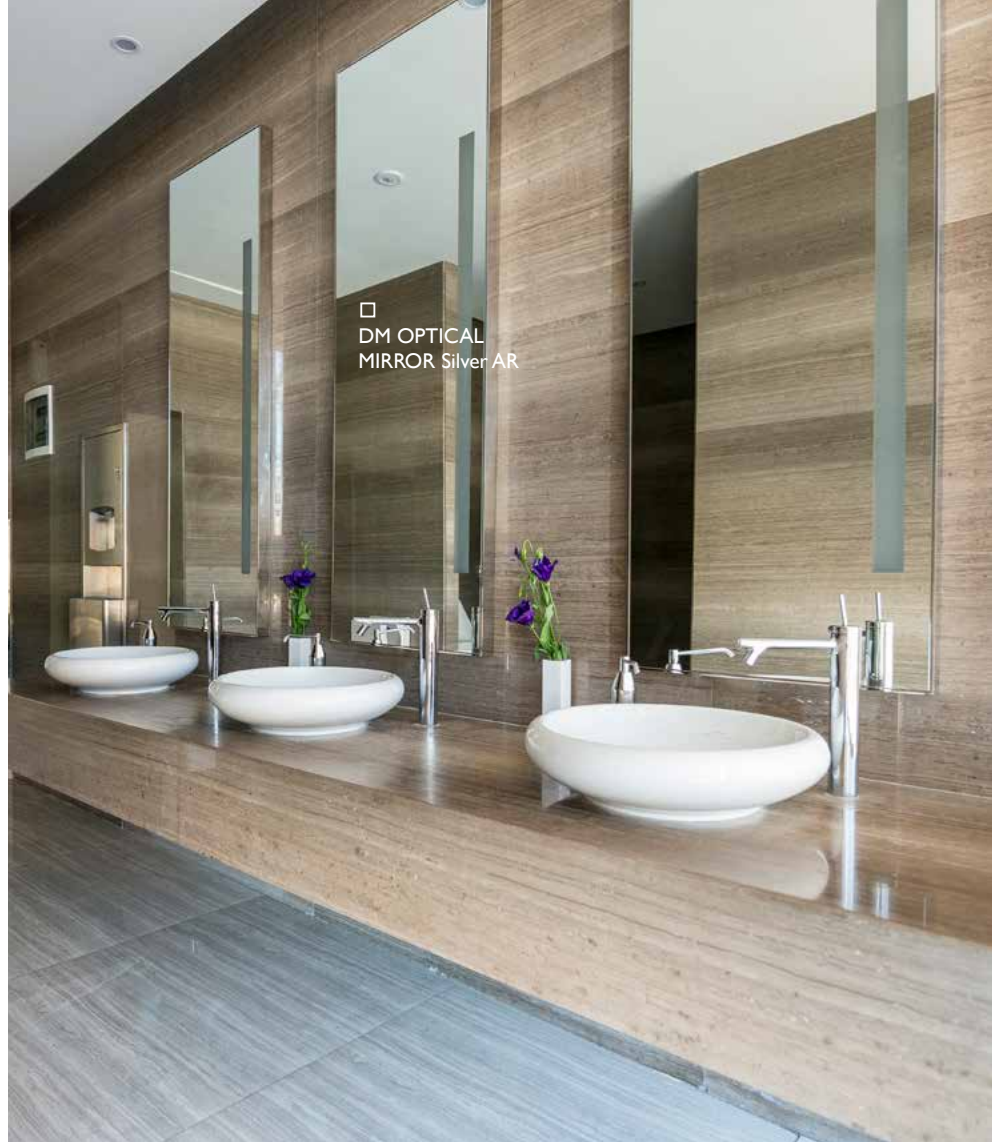
**DM OPTICAL MIRROR Brass AR**  
2800 x 1250 / NA 21242



**DM OPTICAL MIRROR Gold AR**  
2800 x 1250 / NA 21243



**DM OPTICAL MIRROR Copper AR**  
2800 x 1250 / NA 21245



DECO-LINE **abrasion-resistant**

# DM OPTICAL MIRROR AR

### Product characteristics

	NA
Base material	HIPS
Surface material	PET
Material thickness mm	1,0
Temperature stability	up to 60 °C
Wet room suitability	■■■□
Abrasion resistance	■■■■■■■
Rolled packable	✓

### Processing

	NA
Cutting, punching	✓
Drilling	✓
Sawing, milling	✓
Laser cutting	✓
Hot bending	✓
Thermoforming	—
PVA compressible	✓
Smallest bending radius	150 mm

### Extra equipment

	NA
Special formats	On request
Further thicknesses	✓
Cuttings	✓
Magnetic from 3 sheets	—
PVA pre-treatment	✓

### Accessories

SIBUKLE	—
---------	---

### Special colors

—
---



**DM Silver MMS**  
2600 x 1000 / **NA** 20499 / **SA** 20501



**DM Gold MMS**  
2600 x 1000 / **NA** 20500 / **SA** 20502

## DECO-LINE

# DM MMS

### Product characteristics

	NA	SA
Base material	HIPS	
Surface material	Print	
Material thickness mm	1,0	1,13
Temperature stability	up to 60 °C	
Wet room suitability	■■■□	
Abrasion resistance	■■■□□□	
Rolled packable	✓	✓

### Processing

	NA	SA
Cutting, punching	✓	✓
Drilling	✓	✓
Sawing, milling	✓	—
Laser cutting	✓	✓
Hot bending	✓	—
Thermoforming	—	—
PVA compressible	✓	—
Smallest bending radius	150 mm	

### Extra equipment

	NA	SA
Special formats	On request	
Further thicknesses	✓	✓
Cuttings	✓	✓
Magnetic from 3 sheets	✓	
PVA pre-treatment	✓	—

### Accessories

SIBUKLE	Spatula A1
---------	------------

### Special colors

On request
------------



FR  
PR+

**DM Silver**

2600 x 1000 / 1 mm / **NA** 10312 / **SA** 10324  
 2000 x 1000 / 1 mm / **NA** 10304 / **SA** 10322  
 2000 x 1000 / 2 mm / **NA** 12114 / **SA** 10323



FR  
PR+

**DM Silver/White**

2000 x 1000 / 1 mm / **NA** 10372 / **SA** 10381



DECO-LINE

**DM Mirror**

**Product characteristics**

	NA	SA
Base material	HIPS	
Surface material	PET	
Material thickness mm	1,0 / 2,0	1,13 / 2,13
Temperature stability	up to 60 °C	
Wet room suitability	■■■■□	
Abrasion resistance	■■■■□□	
Rolled packable	✓	✓

**Processing**

	NA	SA
Cutting, punching	✓	✓
Drilling	✓	✓
Sawing, milling	✓	—
Laser cutting	✓	✓
Hot bending	✓	—
Thermoforming	✓	—
PVA compressible	✓	—
Smallest bending radius	150 mm	

**Extra equipment**

	NA	SA
Special formats	On request	
Further thicknesses	✓	✓
Cuttings	✓	✓
Magnetic from 3 sheets	✓	
PVA pre-treatment	✓	—

**Accessories**

SIBUKLE	Spatula A1
---------	------------

**Special colors**

On request
------------





□ DM Gold AR



FR  
PR+

**DM Gold AR**

2600 x 1000 / **NA** I0181 / **SA** I0187  
2000 x 1000 / **NA** I0178 / **SA** I0186



FR  
PR+

**DM Rosegold AR**

2600 x 1000 / **NA** 20955 / **SA** 20956



FR  
PR+

**DM Brass AR**

2600 x 1000 / **NA** I0135 / **SA** I0139

DECO-LINE abrasion-resistant

# DM Mirror AR

**Product characteristics**

	NA	SA
Base material	HIPS	
Surface material	PET	
Material thickness mm	1,0	1,13
Temperature stability	up to 60 °C	
Wet room suitability	■■■■□	
Abrasion resistance	■■■■■■■	
Rolled packable	✓	✓

**Processing**

	NA	SA
Cutting, punching	✓	✓
Drilling	✓	✓
Sawing, milling	✓	—
Laser cutting	✓	✓
Hot bending	✓	—
Thermoforming	✓	—
PVA compressible	✓	—
Smallest bending radius	150 mm	

**Extra equipment**

	NA	SA
Special formats	On request	
Further thicknesses	✓	✓
Cuttings	✓	✓
Magnetic from 3 sheets	✓	
PVA pre-treatment	✓	—

**Accessories**

SIBUKLE	Spatula A I
---------	-------------

**Special colors**

—
---



**DM Anthracite AR**  
2600 x 1000 / **NA** 10120 / **SA** 10125



**DM Brown AR**  
2600 x 1000 / **NA** 10147 / **SA** 10150



**DM Rose AR**  
2600 x 1000 / **NA** 10271 / **SA** 12428



**DM Iceblue AR**  
2600 x 1000 / **NA** 10204 / **SA** 10210



**DM Fashion Grey AR**  
2600 x 1000 / **NA** 13808 / **SA** 13810



□ DM Rose AR

Photo: © Form Factory

DECO-LINE abrasion-resistant

# DM Mirror AR

## Product characteristics

	NA	SA
Base material	HIPS	
Surface material	PET	
Material thickness mm	1,0	1,13
Temperature stability	up to 60 °C	
Wet room suitability	■■■□	
Abrasion resistance	■■■■■■■	
Rolled packable	✓	✓

## Processing

	NA	SA
Cutting, punching	✓	✓
Drilling	✓	✓
Sawing, milling	✓	—
Laser cutting	✓	✓
Hot bending	✓	—
Thermoforming	✓	—
PVA compressible	✓	—
Smallest bending radius	150 mm	

## Extra equipment

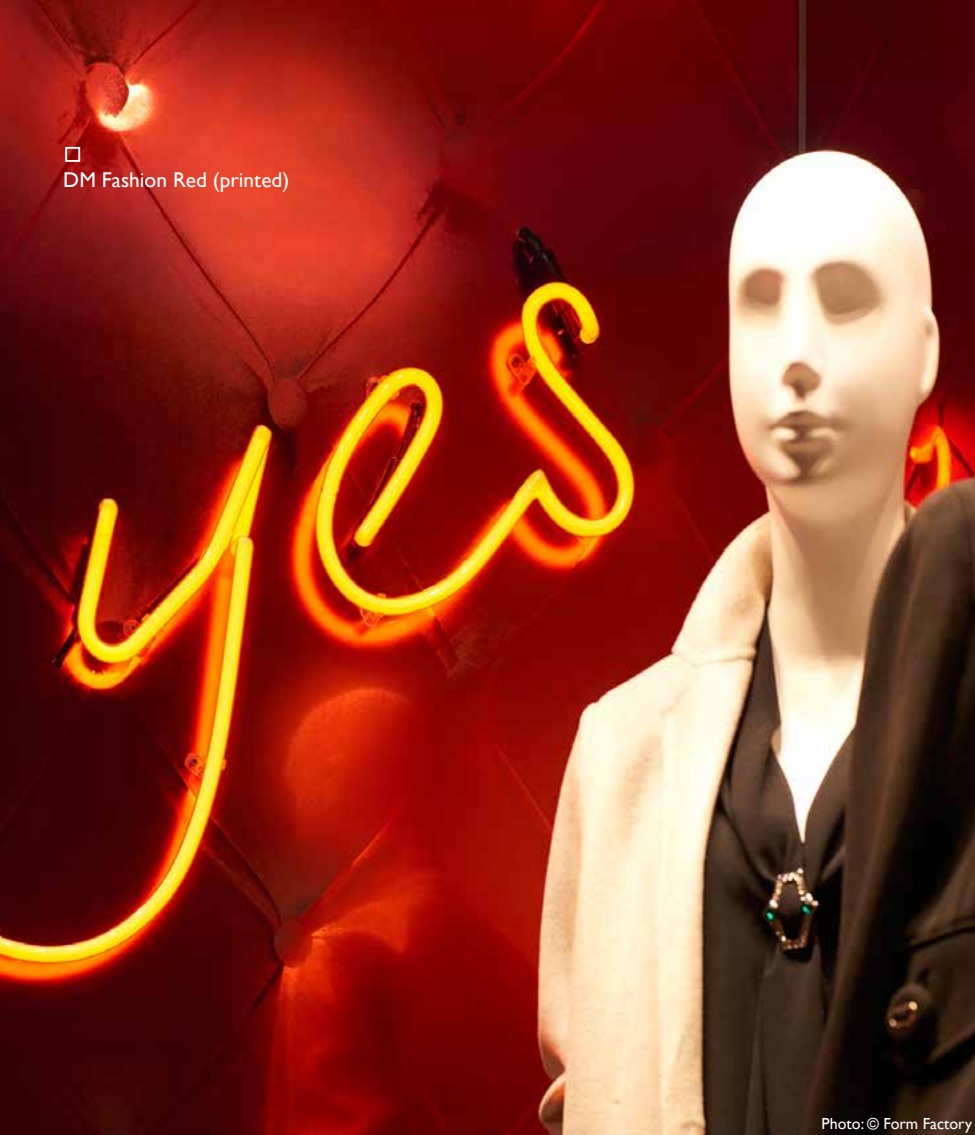
	NA	SA
Special formats	On request	
Further thicknesses	✓	✓
Cuttings	✓	✓
Magnetic from 3 sheets	✓	
PVA pre-treatment	✓	—

## Accessories

SIBUKLE	Spatula A1
---------	------------

## Special colors

—
---



□ DM Fashion Red (printed)

Photo: © Form Factory



**DM Bronze**  
2600 x 1000 / **NA** 10143 / **SA** 15275



**DM Champagne**  
2600 x 1000 / **NA** 12416 / **SA** 12430



**DM Gold 30**  
2600 x 1000 / **NA** 10222/ **SA** 11504



**DM Fashion Red**  
2600 x 1000 / **NA** 10213 / **SA** 13807

## DECO-LINE

# DM Mirror

### Product characteristics

	NA	SA
Base material	HIPS	
Surface material	PET	
Material thickness mm	1,0	1,13
Temperature stability	up to 60 °C	
Wet room suitability	■■■■□	
Abrasion resistance	■■■■□□	
Rolled packable	✓	✓

### Processing

	NA	SA
Cutting, punching	✓	✓
Drilling	✓	✓
Sawing, milling	✓	—
Laser cutting	✓	✓
Hot bending	✓	—
Thermoforming	✓	—
PVA compressible	✓	—
Smallest bending radius	150 mm	

### Extra equipment

	NA	SA
Special formats	On request	
Further thicknesses	✓	✓
Cuttings	✓	✓
Magnetic from 3 sheets	✓	
PVA pre-treatment	✓	—

### Accessories

SIBUKLE	Spatula A1
---------	------------

### Special colors

—
---





FR

**DM Brass brushed matt AR**  
2600 x 1000 / **NA** 15290 / **SA** 15298



FR

**DM Gold brushed matt AR**  
2600 x 1000 / **NA** 15291 / **SA** 15299



□  
DM Gold  
brushed matt AR

DECO-LINE abrasion-resistant

# DM Brushed matt

2600 x 1000



+ ▼

### Product characteristics

	NA	SA
Base material	HIPS	
Surface material	PET	
Material thickness mm	1,0	1,13
Temperature stability	up to 60 °C	
Wet room suitability	■■■■□	
Abrasion resistance	■■■■■■■	
Rolled packable	✓	✓

### Processing

	NA	SA
Cutting, punching	✓	✓
Drilling	✓	✓
Sawing, milling	✓	—
Laser cutting	✓	✓
Hot bending	✓	—
Thermoforming	✓	—
PVA compressible	✓	—
Smallest bending radius	150 mm	

### Extra equipment

	NA	SA
Special formats	On request	
Further thicknesses	✓	✓
Cuttings	✓	✓
Magnetic from 3 sheets	✓	
PVA pre-treatment	✓	—

### Accessories

SIBUKLE	Spatula A1
---------	------------

### Special colors

—
---



□ DM Silver brushed



FR  
PR+

**DM Silver brushed**  
2600 x 1000 / **NA** 10291 / **SA** 10298  
2000 x 1000 / **NA** 10286 / **SA** 10296



FR  
PRS

**DM HGS**  
2600 x 1000 / **NA** 10193 / **SA** 10199



FR  
PRS

**DM Champagne brushed**  
2600 x 1000 / **NA** 12417 / **SA** 12433



FR  
PRS

**DM Titan brushed**  
2600 x 1000 / **NA** 12285 / **SA** 12431



FR  
PRS

**DM Copper brushed**  
2600 x 1000 / **NA** 12418 / **SA** 12432

2600 x 1000



+ ▾

DECO-LINE abrasion-resistant

# DM Brushed

## Product characteristics

	NA	SA
Base material	HIPS	
Surface material	PET	
Material thickness mm	1,0	1,13
Temperature stability	up to 60 °C	
Wet room suitability	■■■■□	
Abrasion resistance	■■■■■■■	
Abrasion resistance DM Silver brushed	■■■■■■□	
Rolled packable	✓	✓

## Processing

	NA	SA
Cutting, punching	✓	✓
Drilling	✓	✓
Sawing, milling	✓	—
Laser cutting	✓	✓
Hot bending	✓	—
Thermoforming	✓	—
PVA compressible	✓	—
Smallest bending radius	150 mm	

## Extra equipment

	NA	SA
Special formats	On request	
Further thicknesses	✓	✓
Cuttings	✓	✓
Magnetic from 3 sheets	✓	
PVA pre-treatment	✓	—

## Accessories

SIBUKLE	Spatula A1
---------	------------

## Special colors

—
---



PR+

**DM DEEP BRUSHED Gravel**  
2600 x 1000 / **NA** 22822 / **SA** 22823



PR+

**DM DEEP BRUSHED Sandy**  
2600 x 1000 / **NA** 22825 / **SA** 22824



□ DM DEEP BRUSHED Gravel

Photo: © iStock.com

2600 x 1000



+ ▾

## DECO-LINE

# DM DEEP BRUSHED

### Product characteristics

	NA	SA
Base material	HIPS	
Surface material	PP	
Material thickness mm	1,3	1,43
Temperature stability	up to 60 °C	
Wet room suitability	■■■■□	
Abrasion resistance	■■■■■■■	
Rolled packable **	✓	✓

### Processing

	NA	SA
Cutting, punching	✓	✓
Drilling	✓	✓
Sawing, milling	✓	—
Laser cutting	✓	✓
Hot bending	✓	—
Thermoforming	—	—
PVA compressible	✓	—
Smallest bending radius	150 mm	

### Extra equipment

	NA	SA
Special formats	On request	
Further thicknesses	✓	✓
Cuttings	✓	✓
Magnetic from 3 sheets ***	✓	
PVA pre-treatment	✓	—

### Accessories

SIBUKLE	Spatula Al
---------	------------

### Special colors

—
---

\*\* Design sheets to be rolled with the decor side outwardly (both – NA and SA version). We recommend rolling not more than 3 sheets per carton (480 x 480 mm).  
\*\*\* Ground must be a SIBU metal foil SA (ref. 17637, self adhesive).

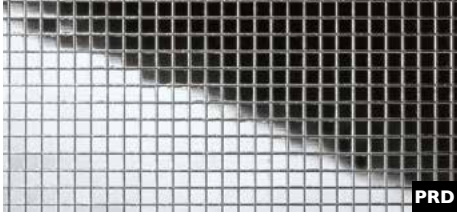




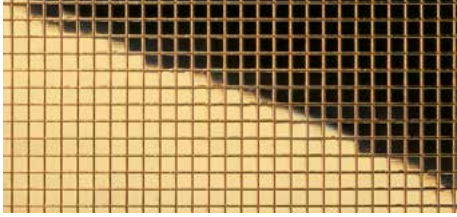


# MULTISTYLE





**MS 3x3 flex Classic Silver**  
980 x 980 / SA 10650



**MS 3x3 flex Classic Gold AR**  
980 x 980 / SA 10592



## MULTISTYLE MS 3x3

### Product characteristics

	SA
Base material	HIPS
Surface material	PET
Material thickness mm	1,2
Temperature stability	up to 50 °C
Wet room suitability	■■■□
Abrasion resistance	■■■■□□
Abrasion resistance MS Gold AR	■■■■■■
Rolled packable	✓

### Processing

	SA
Cutting, punching	✓
Drilling	✓
Sawing, milling	—
Laser cutting	✓
Hot bending	—
PVA compressible	—

### Extra equipment

	SA
Special formats	—
Further thicknesses	—
Cuttings	✓
Magnetic from 3 sheets	✓
PVA pre-treatment	—

### Accessories

SIBUKLE	Spatula AI
---------	------------

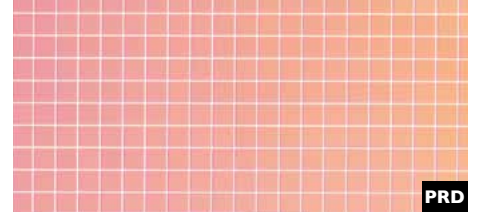
### Special colors

On request
------------



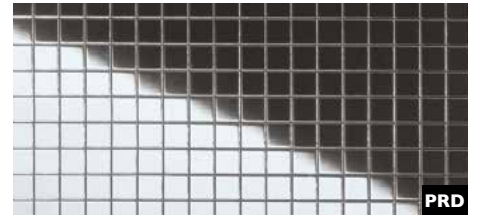
□ MS 5x5 flex Classic Gold AR

Photo: TENN X KAREN MILLEN



PRD

**MS 5x5 flex Classic Hollywood**  
980 x 980 / SA 18436



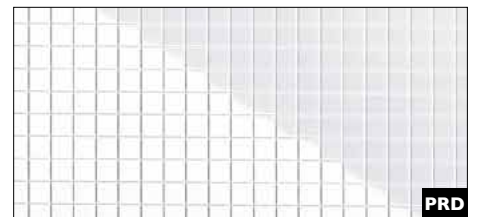
PRD

**MS 5x5 flex Classic Silver**  
980 x 980 / SA 10657



PRD

**MS 5x5 flex Classic Gold AR**  
980 x 980 / SA 10598



PRD

**MS 5x5 flex Classic MAGIC White**  
980 x 980 / SA 13476

## MULTISTYLE MS 5x5

### Product characteristics

	SA
Base material	HIPS
Surface material	PET
Material thickness mm	1,2
Temperature stability	up to 50 °C
Wet room suitability	■■■□
Wet room suitability Magic White	■■■■
Abrasion resistance	■■■■□□
Abrasion resistance MS Gold AR	■■■■■■
Rolled packable	✓

### Extra equipment

	SA
Special formats	✓
Maximum length mm	3000
Maximum width mm	1000
Further thicknesses	—
Cuttings	✓
Magnetic from 3 sheets	✓
PVA pre-treatment	—

### Processing

	SA
Cutting, punching	✓
Drilling	✓
Sawing, milling	—
Laser cutting	✓
Hot bending	—
PVA compressible	—

### Accessories

SIBUKLE	Spatula A I
---------	-------------

### Special colors

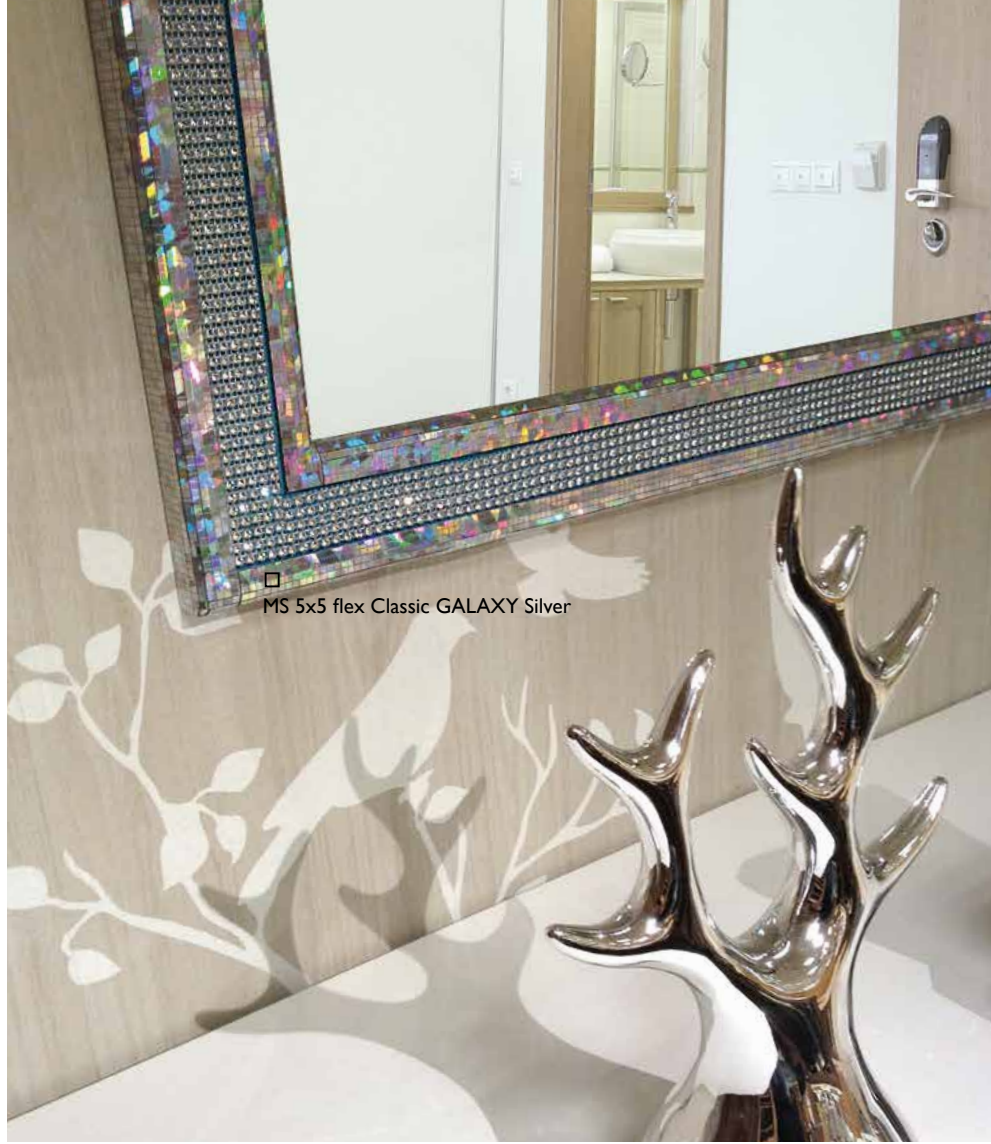
On request
------------





**MS 5x5 flex Classic GALAXY Silver**  
980 x 980 / SA 10575

PRD



□ MS 5x5 flex Classic GALAXY Silver

## MULTISTYLE

# MS 5x5

### Product characteristics

	SA
Base material	HIPS
Surface material	Print
Material thickness mm	1,2
Temperature stability	up to 50 °C
Wet room suitability	■■■□
Abrasion resistance	■■■■■□
Rolled packable	✓

### Processing

	SA
Cutting, punching	✓
Drilling	✓
Sawing, milling	—
Laser cutting	✓
Hot bending	—
PVA compressible	—

### Extra equipment

	SA
Special formats	✓
Maximum length mm	3000
Maximum width mm	1000
Further thicknesses	—
Cuttings	✓
Magnetic from 3 sheets	✓
PVA pre-treatment	—

### Accessories

SIBUKLE	Spatula A1
---------	------------

### Special colors

—
---





Photo: Spacetekusa



**MSC 10x10 flex Classic Silver**  
2600 x 1000 / SA 14239



**MSC 30x30 flex Classic Silver**  
2600 x 1000 / SA 14279

## MULTISTYLE

# MSC 10x10 / 30x30

2600 x 1000

### Product characteristics

	SA
Base material	HIPS
Surface material	PET
Material thickness mm	1,2
Temperature stability	up to 50 °C
Wet room suitability	■■■□
Abrasion resistance	■■■■□□
Rolled packable	✓

### Extra equipment

	SA
Special formats	✓
Maximum length mm	3000
Maximum width mm	1000
Further thicknesses	—
Cuttings	✓
Magnetic from 3 sheets	✓
PVA pre-treatment	—

### Processing

	SA
Cutting, punching	✓
Drilling	✓
Sawing, milling	—
Laser cutting	✓
Hot bending	—
PVA compressible	—

### Accessories

SIBUKLE	Spatula A1
---------	------------

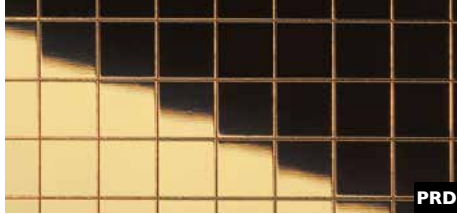
### Special colors

On request
------------





**MS 10x10 flex Classic Silver**  
980 x 980 / SA 10639



**MS 10x10 flex Classic Gold AR**  
980 x 980 / SA 10581



**MS 20x20 flex Classic Silver**  
980 x 980 / SA 10644



**MS 20x20 flex Classic Gold AR**  
980 x 980 / SA 10582



MS 20x20 flex Classic Silver

MS Silver 10x10 flex Classic

Photo: Malo Clinic at El Corte Ingles – Lisboa

## MULTISTYLE

# MS 10x10 / 20x20

### Product characteristics

	SA
Base material	HIPS
Surface material	PET
Material thickness mm	1,2
Temperature stability	up to 50 °C
Wet room suitability	■■■□
Abrasion resistance	■■■■□□
Abrasion resistance MS Gold AR	■■■■■■
Rolled packable	✓

### Extra equipment

	SA
Special formats	✓
Maximum length mm	3000
Maximum width mm	1000
Further thicknesses	—
Cuttings	✓
Magnetic from 3 sheets	✓
PVA pre-treatment	—

### Processing

	SA
Cutting, punching	✓
Drilling	✓
Sawing, milling	—
Laser cutting	✓
Hot bending	—
PVA compressible	—

### Accessories

SIBUKLE	Spatula AI
---------	------------

### Special colors

On request
------------



□  
MS 10x10 flex Classic Gold







# STRUCTURE- LINE



**SL CRASHED OLD Platin**  
2600 x 1000 / **NA** 19519 / **SA** 19523

PRD



□ SL CRASHED OLD Platin

Photo: Dekomat AG - Creative Expert

2600 x 1000



+ ▼

## STRUCTURE-LINE

# SL CRASHED OLD Platin

### Product characteristics

	NA	SA
Base material	HIPS	
Surface material	Print	
Material thickness mm	1,0	1,13
Max. relief height mm	2,8	3,04
Temperature stability	up to 60 °C	
Wet room suitability	■■■■□	
Abrasion resistance	■■■■■□	
Rolled packable	✓	✓

### Processing

	NA	SA
Cutting, punching	✓	✓
Drilling	✓	✓
Sawing, milling	✓	—
Laser cutting	✓	✓
Hot bending	✓	—
PVA compressible	✓	—
Smallest bending radius	150 mm	

### Extra equipment

	NA	SA
Special formats	—	—
Further thicknesses	—	—
Cuttings	✓	✓
Magnetic from 3 sheets *	✓	
PVA pre-treatment	✓	—

### Accessories

SIBUKLE	Spatula A2
---------	------------

### Special colors

On request
------------

\* Ground must be a SIBU metal foil SA (ref. 17637, self adhesive).





□  
SL CRASHED Silver



FR  
PRD

**SL CRASHED Silver**  
2600 x 1000 / **NA** 19335 / **SA** 19346

Photo: © fotolia.com

## STRUCTURE-LINE SL CRASHED

2600 x 1000

### Product characteristics

	NA	SA
Base material	HIPS	
Surface material	PET	
Material thickness mm	1,0	1,13
Max. relief height mm	2,4	2,64
Temperature stability	up to 60 °C	
Wet room suitability	■■■■□	
Abrasion resistance	■■■■□□	
Rolled packable	✓	✓

### Processing

	NA	SA
Cutting, punching	✓	✓
Drilling	✓	✓
Sawing, milling	✓	—
Laser cutting	✓	✓
Hot bending	✓	—
PVA compressible	✓	—
Smallest bending radius	150 mm	

### Extra equipment

	NA	SA
Special formats	—	
Further thicknesses	—	—
Cuttings	✓	✓
Magnetic from 3 sheets *	✓	
PVA pre-treatment	✓	—

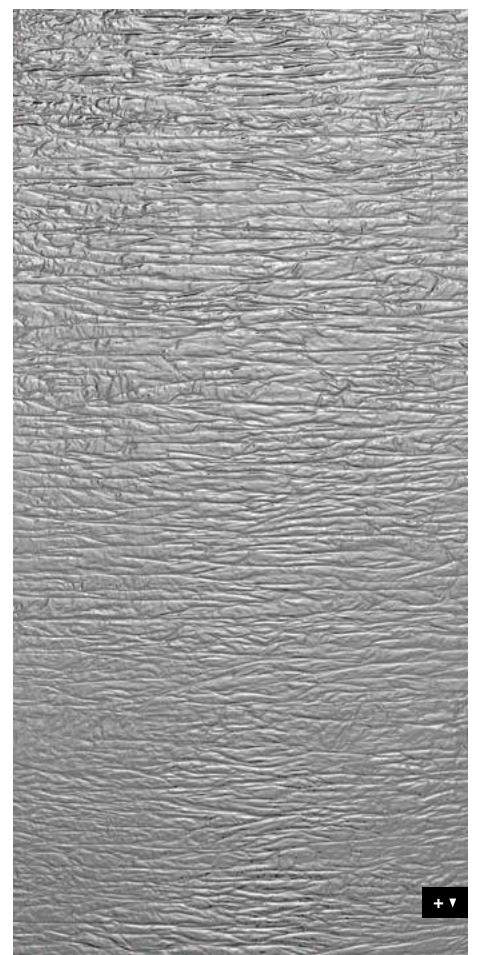
### Accessories

SIBUKLE	Spatula A2
---------	------------

### Special colors

On request
------------

\* Ground must be a SIBU metal foil SA (ref. 17637, self adhesive).







**SL IMPACT VINTAGE Silver**  
2600 x 1000 / **NA** 17230 / **SA** 17231



**SL IMPACT ANTIQUE Bronze**  
2600 x 1000 / **NA** 17232 / **SA** 17233



□ SL IMPACT ANTIQUE Bronze



Photo: © amst - fotolia.com

2600 x 1000



## STRUCTURE-LINE SL IMPACT

### Product characteristics

	NA	SA
Base material	HIPS	
Surface material	Print	
Material thickness mm	1,0	1,13
Max. relief height mm	1,6	1,73
Temperature stability	up to 60 °C	
Wet room suitability	■■■■□	
Abrasion resistance	■■■■■□	
Rolled packable	✓	✓

### Processing

	NA	SA
Cutting, punching	✓	✓
Drilling	✓	✓
Sawing, milling	✓	—
Laser cutting	✓	✓
Hot bending	✓	—
PVA compressible	✓	—
Smallest bending radius	150 mm	

### Extra equipment

	NA	SA
Special formats	—	—
Further thicknesses	—	—
Cuttings	✓	✓
Magnetic from 3 sheets	✓	
PVA pre-treatment	✓	—

### Accessories

SIBUKLE	Spatula A2
---------	------------

### Special colors

On request
------------





□  
SL MOTION TWO  
MAGIC Black AR

Photo: GARANTküche



**SL MOTION TWO MAGIC Black AR**  
2600 x 1000 / **NA** 23575 / **SA** 23665

## STRUCTURE-LINE

# SL MOTION TWO MAGIC Black AR

2600 x 1000

### Product characteristics

	NA	SA
Base material	HIPS	
Surface material	Print	
Material thickness mm	1,0	1,13
Max. relief height mm	1,5	1,63
Temperature stability	up to 60 °C	
Wet room suitability	■■■■■	
Abrasion resistance	■■■■■□	
Rolled packable	✓	✓

### Processing

	NA	SA
Cutting, punching	✓	✓
Drilling	✓	✓
Sawing, milling	✓	—
Laser cutting	✓	✓
Hot bending	✓	—
PVA compressible	✓	—
Smallest bending radius	150 mm	

### Extra equipment

	NA	SA
Special formats	—	—
Further thicknesses	—	—
Cuttings	✓	✓
Magnetic from 3 sheets	✓	
PVA pre-treatment	✓	—

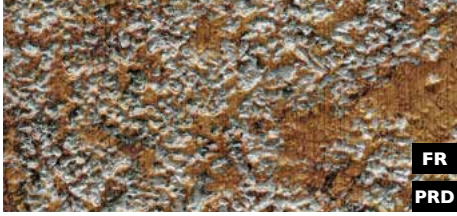
### Accessories

SIBUKLE	Spatula A2
---------	------------

### Special colors

On request
------------





FR  
PRD

**SL LAVA VINTAGE Copper**  
2600 x 1000 / **NA** 14786 / **SA** 14805



2600 x 1000



+ ▾

## STRUCTURE-LINE

# SL LAVA

### Product characteristics

	NA	SA
Base material	HIPS	
Surface material	Print	
Material thickness mm	1,0	1,25
Max. relief height mm	2,1	2,35
Temperature stability	up to 60 °C	
Wet room suitability	■■■■□	
Abrasion resistance	■■■■■□	
Rolled packable	✓	✓

### Processing

	NA	SA
Cutting, punching	✓	✓
Drilling	✓	✓
Sawing, milling	✓	—
Laser cutting	✓	✓
Hot bending	✓	—
PVA compressible	✓	—
Smallest bending radius	150 mm	

### Extra equipment

	NA	SA
Special formats	—	—
Further thicknesses	—	—
Cuttings	✓	✓
Magnetic from 3 sheets	✓	
PVA pre-treatment	✓	—

### Accessories

SIBUKLE	Spatula A2
---------	------------

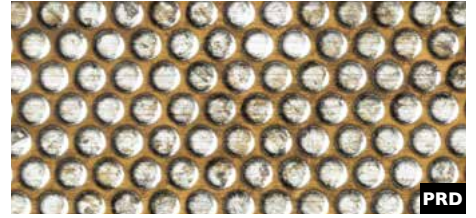
### Special colors

On request
------------



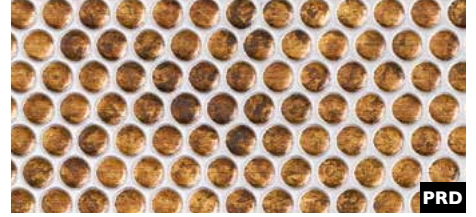


Photo Wilhelm Radinger



PRD

**SL RACE VINTAGE Silver/Bronze**  
2600 x 1000 / **NA** 17242 / **SA** 17243



PRD

**SL RACE VINTAGE Copper/Silver**  
2600 x 1000 / **NA** 17240 / **SA** 17241

## STRUCTURE-LINE SL RACE

### Product characteristics

	NA	SA
Base material	HIPS	
Surface material	Print	
Material thickness mm	1,0	1,13
Max. relief height mm	1,7	1,83
Temperature stability	up to 60 °C	
Wet room suitability	■■■■□	
Abrasion resistance	■■■□□□	
Rolled packable	✓	✓

### Extra equipment

	NA	SA
Special formats	—	—
Further thicknesses	—	—
Cuttings	✓	✓
Magnetic from 3 sheets	✓	
PVA pre-treatment	✓	—

### Processing

	NA	SA
Cutting, punching	✓	✓
Drilling	✓	✓
Sawing, milling	✓	—
Laser cutting	✓	✓
Hot bending	✓	—
PVA compressible	✓	—
Smallest bending radius	150 mm	

### Accessories

SIBUKLE	Spatula A2
---------	------------

### Special colors

On request
------------

2600 x 1000



+ ▼





FR  
PRD

**SL CROCO Silver PF/Silver**  
2600 x 1000 / **NA** I3410 / **SA** I3520



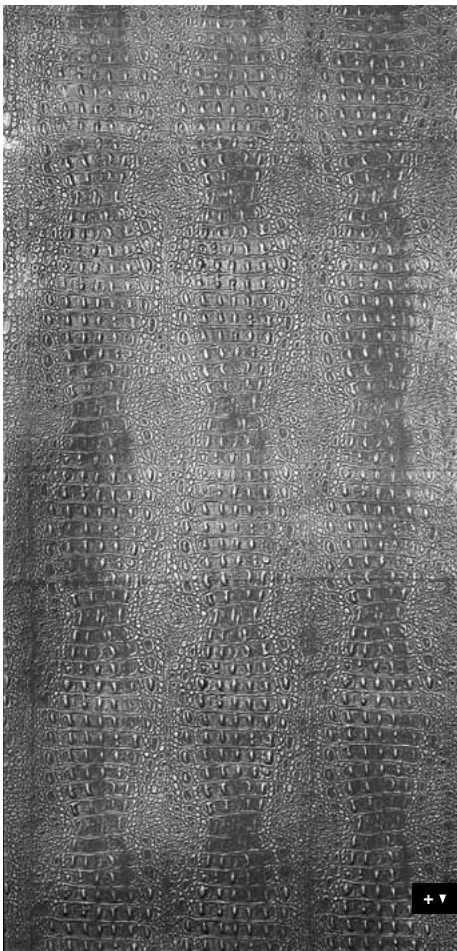
FR  
PRD

**SL CROCO Smoke PF/Silver**  
2600 x 1000 / **NA** I3411 / **SA** I3521



Photo: secetenendrinken.nl

2600 x 1000



+ ▼

## STRUCTURE-LINE SL CROCO

### Product characteristics

	NA	SA
Base material	HIPS	
Surface material	Print	
Material thickness mm	1,0	1,25
Max. relief height mm	2,6	2,85
Temperature stability	up to 60 °C	
Wet room suitability	■■■■□	
Abrasion resistance	■■■■□□	
Rolled packable	✓	✓

### Processing

	NA	SA
Cutting, punching	✓	✓
Drilling	✓	✓
Sawing, milling	✓	—
Laser cutting	✓	✓
Hot bending	✓	—
PVA compressible	✓	—
Smallest bending radius	150 mm	

### Extra equipment

	NA	SA
Special formats	—	—
Further thicknesses	—	—
Cuttings	✓	✓
Magnetic from 3 sheets	✓	
PVA pre-treatment	✓*	—

### Accessories

SIBUKLE	Spatula A2
---------	------------

### Special colors

On request
------------





**SL SQUARE 3 HGS**  
2600 x 1000 / 1,7 mm / **NA** 11272 / **SA** 11273

## STRUCTURE-LINE SL SQUARE 3

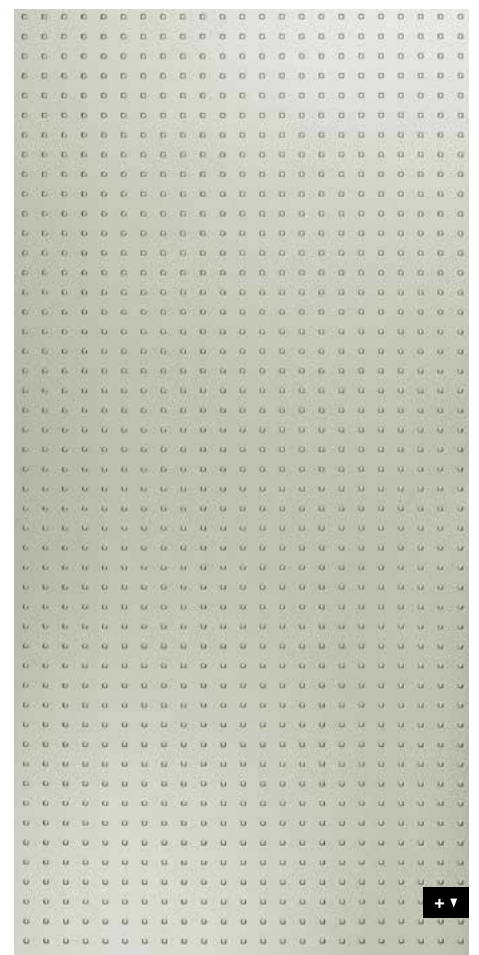
2600 x 1000

### Product characteristics

	NA	SA
Base material	HIPS	
Surface material	PET	
Material thickness mm	1,0	1,13
Max. relief height mm	1,7	1,83
Temperature stability	up to 60 °C	
Wet room suitability	■■■■□	
Abrasion resistance	■■■■■■■	
Rolled packable	✓	✓

### Processing

	NA	SA
Cutting, punching	✓	✓
Drilling	✓	✓
Sawing, milling	✓	—
Laser cutting	✓	✓
Hot bending	✓	—
PVA compressible	✓	—
Smallest bending radius	150 mm	



### Extra equipment

	NA	SA
Special formats	—	
Further thicknesses	—	—
Cuttings	✓	✓
Magnetic from 3 sheets	✓	
PVA pre-treatment	✓	—

### Accessories

SIBUKLE	Spatula A2
---------	------------

### Special colors

On request
------------



# ACRYLIC- LINE

SIBU | DESIGN





**AC MOTION ONE White**  
2600 x 1000 / **NA** 15933 / **SA** 15953



□  
AC MOTION ONE White

Photo: © istock.com

2600 x 1000



ACRYLIC-LINE abrasion-resistant

# AC MOTION ONE

## Product characteristics

	NA	SA
Base material	ABS	
Surface material	PMMA	
Material thickness mm	0,7	0,83
Max. relief height mm	1,1	1,23
Temperature stability	up to 60 °C	
Wet room suitability	■■■■■	
Abrasion resistance	■■■■■□	
Rolled packable	✓	✓

## Processing

	NA	SA
Cutting, punching	✓	✓
Drilling	✓	✓
Sawing, milling	✓	—
Laser cutting	✓	✓
Hot bending	✓	—
PVA compressible	✓	—
Smallest bending radius	150 mm	

## Accessories

SIBUKLE	Spatula A2
Politur-Kit	available
Farbgleiche Kanten	available

## Extra equipment

	NA	SA
Special formats	On request	
Further thicknesses	—	—
Cuttings	✓	✓
Magnetic from 3 sheets	✓	
PVA pre-treatment	✓	—

## Special colors

On request
------------





□ AC MOTION TWO White

Photo: © istock.com



**AC MOTION TWO White**  
2600 x 1000 / **NA** 15755 / **SA** 15764

## ACRYLIC-LINE abrasion-resistant

# AC MOTION TWO

2600 x 1000

### Product characteristics

	NA	SA
Base material	ABS	
Surface material	PMMA	
Material thickness mm	0,7	0,83
Max. relief height mm	1,1	1,23
Temperature stability	up to 60 °C	
Wet room suitability	■■■■■	
Abrasion resistance	■■■■■□	
Rolled packable	✓	✓

### Processing

	NA	SA
Cutting, punching	✓	✓
Drilling	✓	✓
Sawing, milling	✓	—
Laser cutting	✓	✓
Hot bending	✓	—
PVA compressible	✓	—
Smallest bending radius	150 mm	

### Accessories

SIBUKLE	Spatula A2
Politur-Kit	available
Farbgleiche Kanten	available

### Extra equipment

	NA	SA
Special formats	On request	
Further thicknesses	—	—
Cuttings	✓	✓
Magnetic from 3 sheets	✓	
PVA pre-treatment	✓	—

### Special colors

On request
------------





# TRANSLUCENT- LINE



PRD

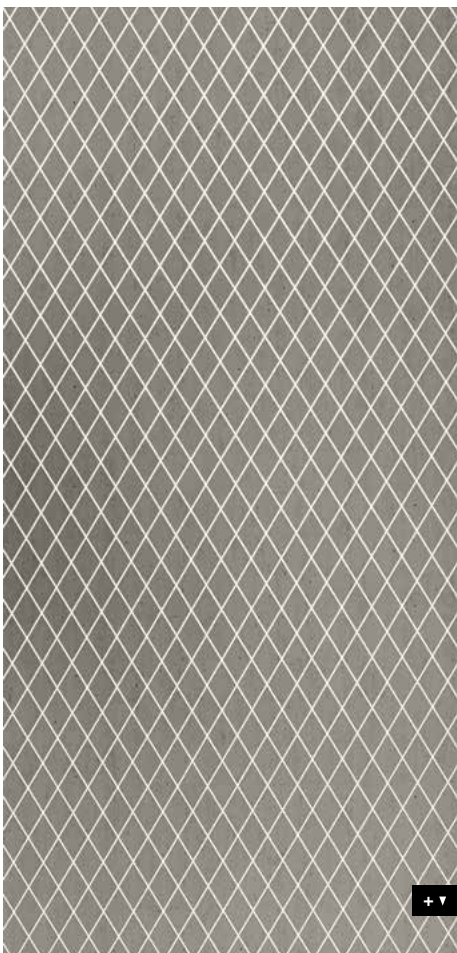
**TL LINEA 104x62 OLD Platin**  
2600 x 1000 / **NA** 18434 / **SA** 18607



TL LINEA 104 x 62 OLD Platin

Photo: Zamfir

2600 x 1000



+ ▾

## TRANSLUCENT-LINE

# TL LINEA

### Product characteristics

	NA	SA
Base material	HIPS	
Surface material	Print	
Material thickness mm	1,5	1,63
Temperature stability	up to 60 °C	
Wet room suitability	■■■□	
Abrasion resistance	■■■■■■■	
Rolled packable	✓	✓

### Processing

	NA	SA
Cutting, punching	✓	✓
Drilling	✓	✓
Sawing, milling	✓	—
Laser cutting	✓	✓
Hot bending	—	—
PVA compressible	—	—
Smallest bending radius	240 mm	

### Extra equipment

	NA	SA
Special formats	On request	
Further thicknesses	—	—
Cuttings	✓	✓
Magnetic	—	
PVA pre-treatment	—	—

### Accessories

SIBUKLE	—
---------	---

### Special colors

On request
------------





□  
TL LINEA  
104 x 62 OLD Platin



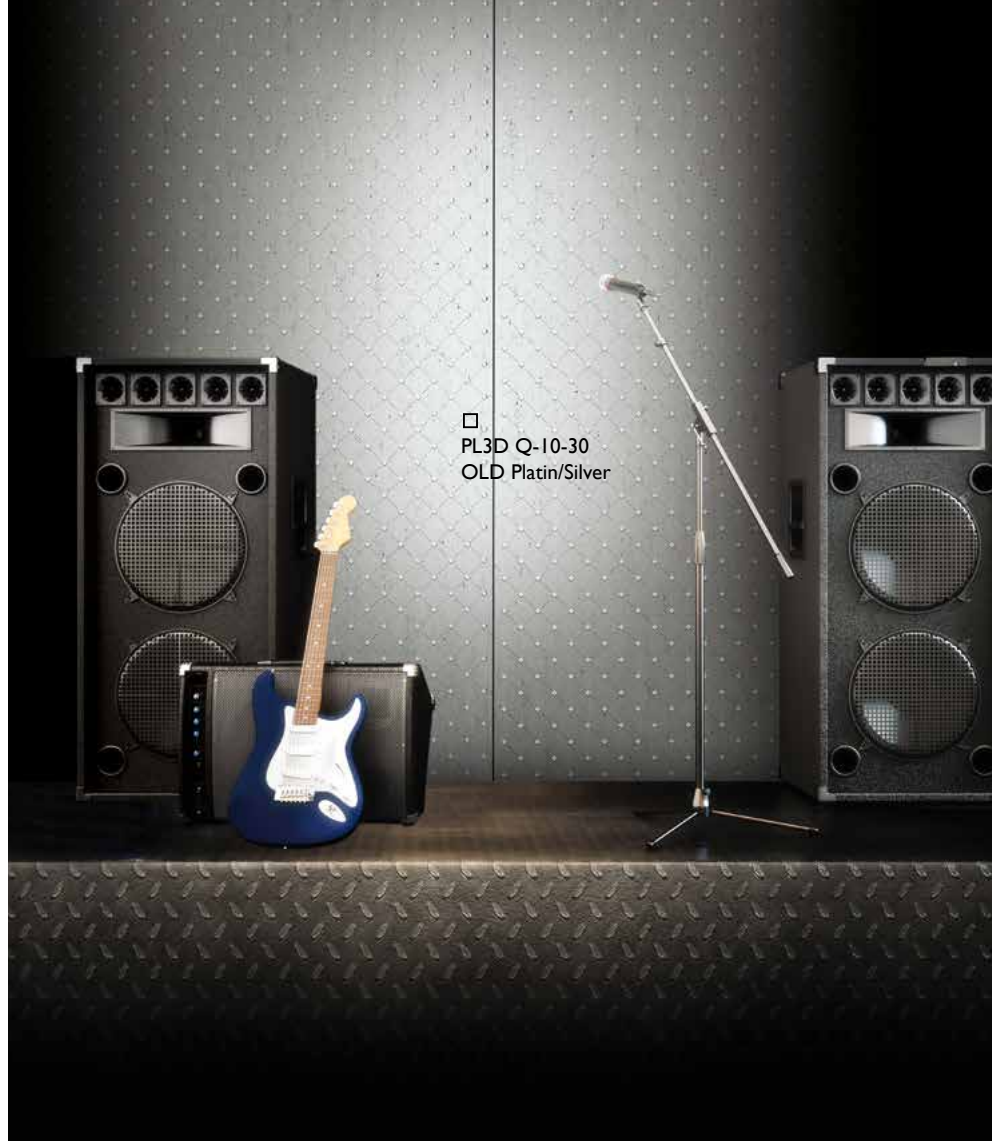


# PUNCH- LINE / 3D



**PL3D Q-10-30 OLD Platin/Silver**  
2600 x 1000 / **NA** 17833 / **SA** 17857

PRD



□ PL3D Q-10-30  
OLD Platin/Silver

2600 x 1000



+ ▾

## PUNCH-LINE / 3D

# PL3D Q-10-30

### Product characteristics

	NA	SA
Base material	APET, HIPS	
Surface material	Print	
Material thickness mm	1,3	1,43
Temperature stability	up to 50 °C	
Wet room suitability	■■■■□	
Abrasion resistance	■■■■■■□	
Rolled packable *	✓	✓

\* Design sheets are to be rolled with the patterned side on the inside (applies for both the NA and SA versions). We recommend that not more than 3 sheets be rolled per carton (480 x 480 mm). (Up to 40° C)

\*\* Up to 40° C

### Processing

	NA	SA
Cutting, punching	✓	✓
Drilling	✓	✓
Sawing, milling	✓	—
Laser cutting	✓	✓
Hot bending	✓	—
PVA compressible	—	—
Smallest bending radius **	300 mm	300 mm

### Extra equipment

	NA	SA
Special formats	—	—
Further thicknesses	—	—
Cuttings	✓	✓
Magnetic from 3 sheets	✓	
PVA pre-treatment	—	—

### Accessories

SIBUKLE	—
---------	---

### Special colors

On request
------------





□  
PL3D H-10-30  
Pearl White PF/Gold



**PL3D H-10-30 Pearl White PF/Gold**  
2600 x 1000 / **NA** 17832 / **SA** 17856

## PUNCH-LINE / 3D

# PL3D H-10-30

2600 x 1000

### Product characteristics

	NA	SA
Base material	APET, HIPS	
Surface material	Print	
Material thickness mm	1,3	1,43
Temperature stability	up to 50 °C	
Wet room suitability	■■■■□	
Abrasion resistance	■■■■■■■	
Rolled packable *	✓	✓

\* Design sheets are to be rolled with the patterned side on the inside (applies for both the NA and SA versions).  
We recommend that not more than 3 sheets be rolled per carton (480 x 480 mm). (Up to 40° C)

\*\* Up to 40° C

### Processing

	NA	SA
Cutting, punching	✓	✓
Drilling	✓	✓
Sawing, milling	✓	—
Laser cutting	✓	✓
Hot bending	✓	—
PVA compressible	—	—
Smallest bending radius **	300 mm	300 mm

### Extra equipment

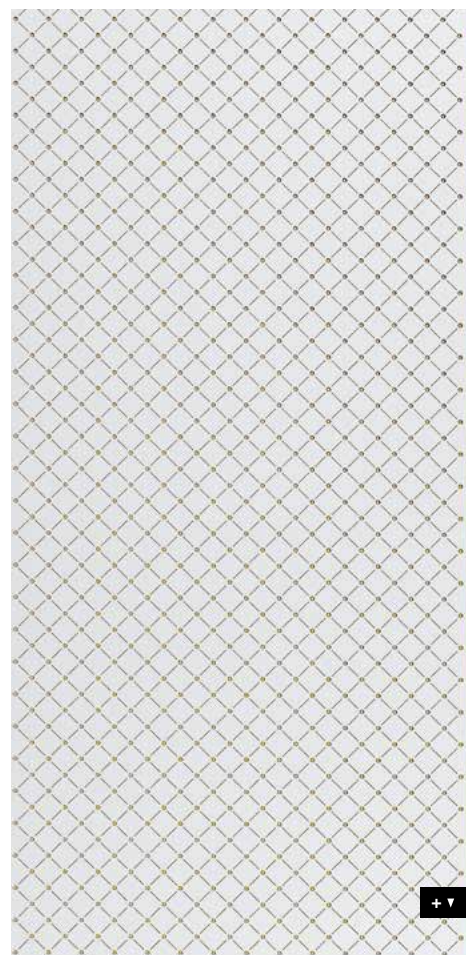
	NA	SA
Special formats	—	—
Further thicknesses	—	—
Cuttings	✓	✓
Magnetic from 3 sheets	✓	
PVA pre-treatment	—	—

### Accessories

SIBUKLE	—
---------	---

### Special colors

On request
------------







**PL3D ROSES Pearl White PF/Gold**  
2600 x 1000 / **NA** I6443 / **SA** I6444



**PL3D ROSES Silver PF/Silver**  
2600 x 1000 / **NA** I3917 / **SA** I3919



PL3D ROSES Silver PF/Silver

Photo: Minotti

2600 x 1000



## PUNCH-LINE / 3D

# PL3D ROSES

### Product characteristics

	NA	SA
Base material	APET / HIPS	
Surface material	Print	
Material thickness mm	1,3	1,43
Temperature stability	up to 50 °C	
Wet room suitability	■■■□	
Abrasion resistance	■■■■■■■	
Rolled packable *	✓	✓

\* Design sheets are to be rolled with the patterned side on the inside (applies for both the NA and SA versions). We recommend that not more than 3 sheets be rolled per carton (480 x 480 mm). (Up to 40° C)  
\*\* Up to 40° C

### Processing

	NA	SA
Cutting, punching	✓	✓
Drilling	✓	✓
Sawing, milling	✓	—
Laser cutting	✓	✓
Hot bending	—	—
PVA compressible	—	—
Smallest bending radius **	300 mm	300 mm

### Extra equipment

	NA	SA
Special formats	—	—
Further thicknesses	—	—
Cuttings	✓	✓
Magnetic from 3 sheets	✓	
PVA pre-treatment	—	—

### Accessories

SIBUKLE	—
---------	---

### Special colors

On request
------------



**PL3D Q 10-40-40 Silver PF/Silver**  
2600 x 1000 / **NA** 10052 / **SA** 10053



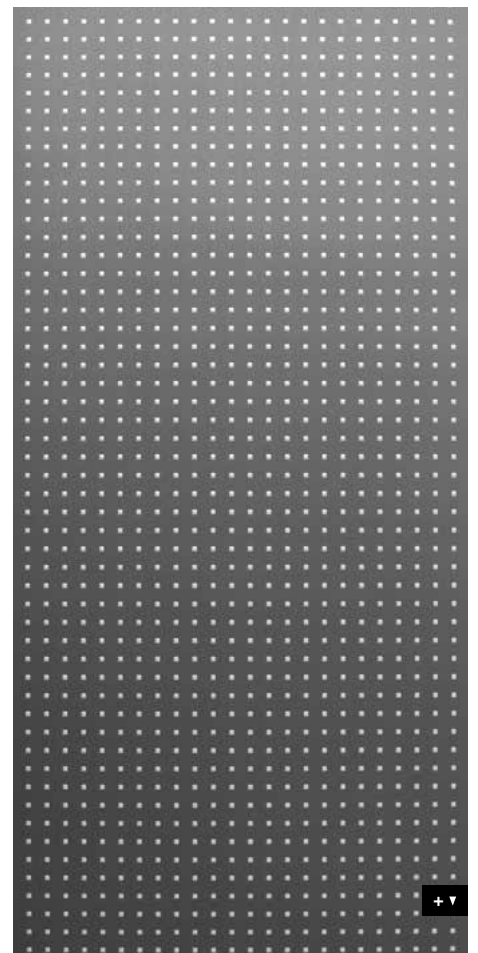
**PL3D Q 10-40-40 Smoke PF TI/Silver matt**  
2600 x 1000 / **NA** 12519 / **SA** 12557

□ PL3D Q 10-40-40 Silver PF/Silver

## PUNCH-LINE / 3D

# PL3D Q 10-40-40

2600 x 1000



### Product characteristics

	NA	SA
Base material	APET / HIPS	
Surface material	Print	
Material thickness mm	1,3	1,43
Temperature stability	up to 50 °C	
Wet room suitability	■■■■□	
Abrasion resistance	■■■■■■■	
Rolled packable *	✓	✓

\* Design sheets are to be rolled with the patterned side on the inside (applies for both the NA and SA versions).  
We recommend that not more than 3 sheets be rolled per carton (480 x 480 mm). (Up to 40° C)

\*\* Up to 40° C

### Processing

	NA	SA
Cutting, punching	✓	✓
Drilling	✓	✓
Sawing, milling	✓	—
Laser cutting	✓	✓
Hot bending	✓	—
PVA compressible	—	—
Smallest bending radius **	300 mm	300 mm

### Extra equipment

	NA	SA
Special formats	—	—
Further thicknesses	—	—
Cuttings	✓	✓
Magnetic from 3 sheets	✓	
PVA pre-treatment	—	—

### Accessories

SIBUKLE	—
---------	---

### Special colors

On request
------------



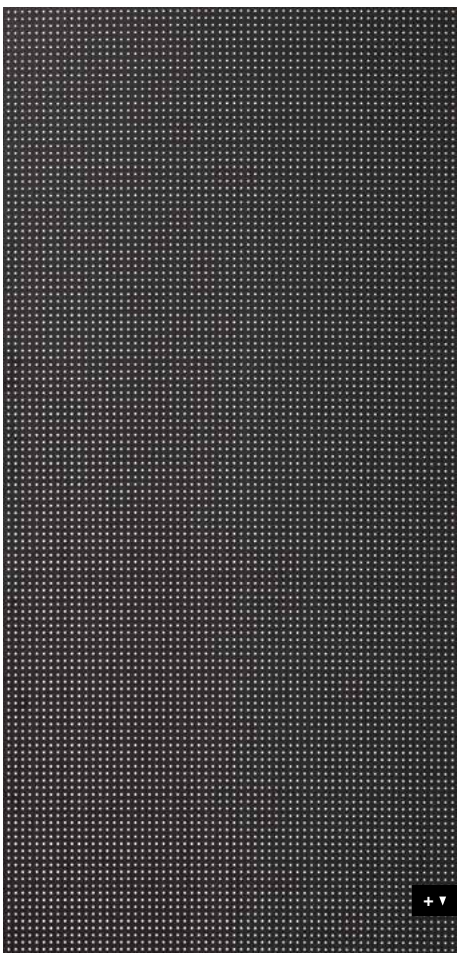


**PL3D Q 5-15-15 Black TI/Silver**  
2600 x 1000 / **NA** 12384 / **SA** 12549



PL3D Q 5-15-15  
Black TI/Silver

2600 x 1000



## PUNCH-LINE / 3D

# PL3D Q 5-15-15

### Product characteristics

	NA	SA
Base material	APET / HIPS	
Surface material	Print	
Material thickness mm	1,3	1,43
Temperature stability	up to 50 °C	
Wet room suitability	■■■■□	
Abrasion resistance	■■■■■■■	
Rolled packable *	✓	✓

\* Design sheets are to be rolled with the patterned side on the inside (applies for both the NA and SA versions). We recommend that not more than 3 sheets be rolled per carton (480 x 480 mm). (Up to 40° C)

\*\* Up to 40° C

### Processing

	NA	SA
Cutting, punching	✓	✓
Drilling	✓	✓
Sawing, milling	✓	—
Laser cutting	✓	✓
Hot bending	✓	—
PVA compressible	—	—
Smallest bending radius **	300 mm	300 mm

### Extra equipment

	NA	SA
Special formats	—	—
Further thicknesses	—	—
Cuttings	✓	✓
Magnetic from 3 sheets	✓	
PVA pre-treatment	—	—

### Accessories

SIBUKLE	—
---------	---

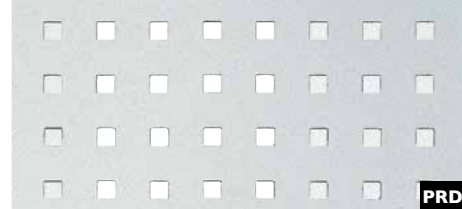
### Special colors

On request
------------



□  
PL Q 5-15-15  
Silver PF

Photo: © fotolia.com



PRD

**PL Q 5-15-15 Silver PF**  
2600 x 1000 / **NA** 10986 / **SA** 10988

## PUNCH-LINE

# PL Q 5-15-15

### Product characteristics

	NA	SA
Base material	HIPS	
Surface material	Print	
Material thickness mm	1,0	1,13
Temperature stability	up to 60 °C	
Wet room suitability	■■■■■	
Abrasion resistance	■■■■■■■	
Rolled packable	✓	✓

### Processing

	NA	SA
Cutting, punching	✓	✓
Drilling	✓	✓
Sawing, milling	✓	—
Laser cutting	✓	✓
Hot bending	✓	—
PVA compressible	—	—
Smallest bending radius	150 mm	150 mm

### Extra equipment

	NA	SA
Special formats	On request	
Further thicknesses	up to 2 mm	
Cuttings	✓	✓
Magnetic	—	
PVA pre-treatment	—	—

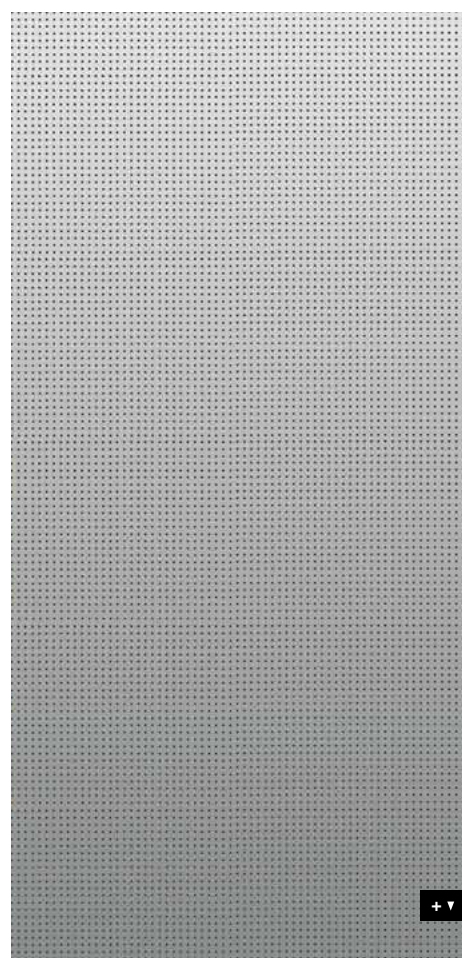
### Accessories

SIBUKLE	—
---------	---

### Special colors

On request
------------

2600 x 1000







# ANTIGRAV

SIBU | DESIGN



**FL CREPA VELVET Avocado AntigraV**  
2613 x 1005 / **NA** 22735



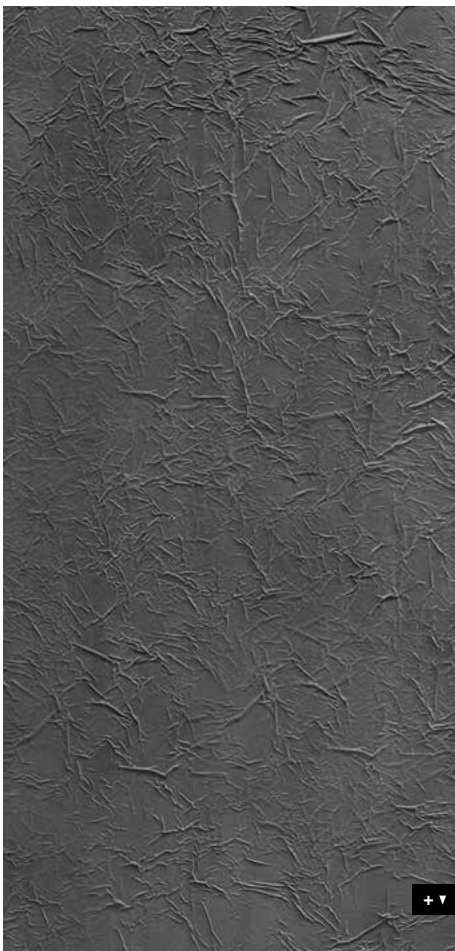
**FL CREPA VELVET Volcano AntigraV**  
2613 x 1005 / **NA** 22736

Please consider the nap direction of the surface before further processing or product installation. If design panels are not installed in the same direction, there will be a visual color difference.



Photo: © istock.com

2613 x 1005



**FABRIC-LINE** POSITIVE ACOUSTIC EFFECT

# FL CREPA VELVET AntigraV

**Product characteristics**

	<b>NA</b>
Base material	PP-glass fibres
Surface material	PET fibres
Material thickness mm	3,9
Max. relief height mm	6
Temperature stability	up to 60 °C
Wet room suitability	■■■■■
Rolled packable	—

**Processing**

	<b>NA</b>
Cutting, punching	✓
Drilling	✓
Sawing	✓
Milling	—
Laser cutting	✓
Hot bending	—
PVA compressible	✓
Smallest bending radius	1000 mm

**Extra equipment**

	<b>NA</b>
Special formats	On request
Cuttings	✓
Magnetic from 3 sheets *	✓
PVA pre-treatment	—

**Accessories**

SIBUKLE	Spatula A2
---------	------------

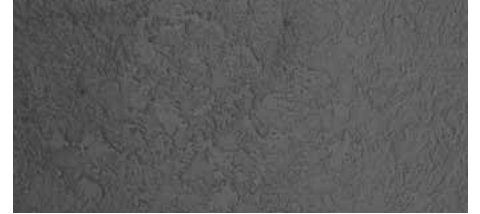
**Special colors**

On request
------------

\* Ground must be a SIBU metal foil SA (ref. 17637, self adhesive).



**FL LAVA VELVET Coal Antigrav**  
2613 x 1005 / NA 22737



**FL LAVA VELVET Volcano Antigrav**  
2613 x 1005 / NA 22738

Please consider the nap direction of the surface before further processing or product installation. If design panels are not installed in the same direction, there will be a visual color difference.

FABRIC-LINE POSITIVE ACOUSTIC EFFECT

# FL LAVA VELVET Antigrav

2613 x 1005

## Product characteristics

	NA
Base material	PP-glass fibres
Surface material	PET fibres
Material thickness mm	3,9
Max. relief height mm	6
Temperature stability	up to 60 °C
Wet room suitability	■■■■■
Rolled packable	—

## Processing

	NA
Cutting, punching	✓
Drilling	✓
Sawing	✓
Milling	—
Laser cutting	✓
Hot bending	—
PVA compressible	✓
Smallest bending radius	1000 mm

## Extra equipment

	NA
Special formats	On request
Cuttings	✓
Magnetic from 3 sheets *	✓
PVA pre-treatment	—

## Accessories

SIBUKLE	Spatula A2
---------	------------

## Special colors

On request
------------

\* Ground must be a SIBU metal foil SA (ref. 17637, self adhesive).



CONTINUOUS PATTERN

### FL COMB VELVET Curry Antigrav

2613 x 1005 / NA 22731

CONTINUOUS PATTERN

### FL COMB VELVET Pearl Antigrav

2613 x 1005 / NA 22732

Please consider the nap direction of the surface before further processing or product installation. If design panels are not installed in the same direction, there will be a visual color difference.



Photo: © istock.com

2613 x 1005



## FABRIC-LINE POSITIVE ACOUSTIC EFFECT

# FL COMB VELVET Antigrav

### Product characteristics

	NA
Base material	PP-glass fibres
Surface material	PET fibres
Material thickness mm	3,9
Max. relief height mm	6
Temperature stability	up to 60 °C
Wet room suitability	■■■■■
Rolled packable	—

### Processing

	NA
Cutting, punching	✓
Drilling	✓
Sawing	✓
Milling	—
Laser cutting	✓
Hot bending	—
PVA compressible	✓
Smallest bending radius	1000 mm

### Extra equipment

	NA
Special formats	On request
Cuttings	✓
Magnetic from 3 sheets *	✓
PVA pre-treatment	—

### Accessories

SIBUKLE	Spatula A2
---------	------------

### Special colors

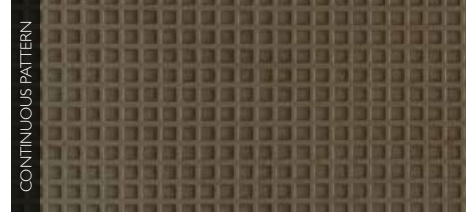
On request
------------

\* Ground must be a SIBU metal foil SA (ref. 17637, self adhesive).



□  
FL SQUARE 2 VELVET Mocha Antigrav

Photo: © istock.com



CONTINUOUS PATTERN  
**FL SQUARE 2 VELVET Mocha Antigrav**  
2613 x 1005 / **NA** 22733



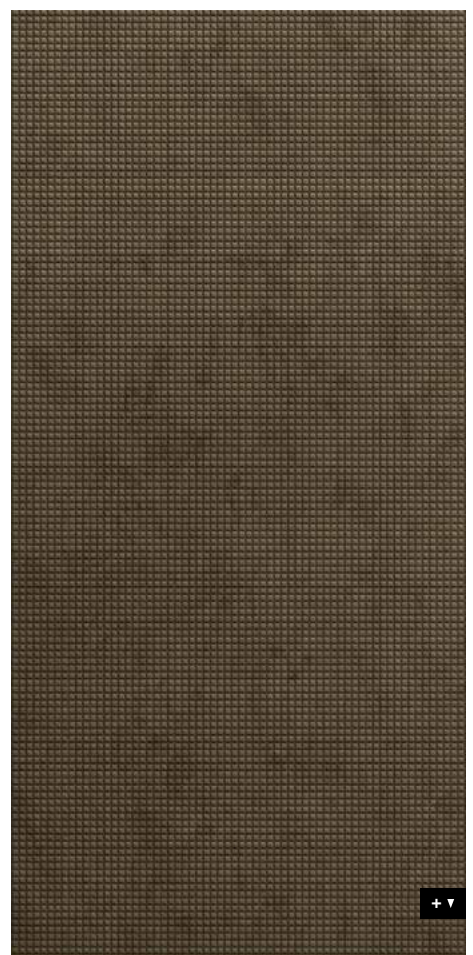
CONTINUOUS PATTERN  
**FL SQUARE 2 VELVET Coal Antigrav**  
2613 x 1005 / **NA** 22734

Please consider the nap direction of the surface before further processing or product installation. If design panels are not installed in the same direction, there will be a visual color difference.

FABRIC-LINE POSITIVE ACOUSTIC EFFECT

# FL SQUARE 2 VELVET Antigrav

2613 x 1005



## Product characteristics

	NA
Base material	PP-glass fibres
Surface material	PET fibres
Material thickness mm	3,9
Max. relief height mm	6
Temperature stability	up to 60 °C
Wet room suitability	■■■■■
Rolled packable	—

## Processing

	NA
Cutting, punching	✓
Drilling	✓
Sawing	✓
Milling	—
Laser cutting	✓
Hot bending	—
PVA compressible	✓
Smallest bending radius	1000 mm

## Extra equipment

	NA
Special formats	On request
Cuttings	✓
Magnetic from 3 sheets *	✓
PVA pre-treatment	—

## Accessories

SIBUKLE	Spatula A2
---------	------------

## Special colors

On request
------------

\* Ground must be a SIBU metal foil SA (ref. 17637, self adhesive).



CONTINUOUS PATTERN

### FL CUBE VELVET Bordeaux Antigrav

2613 x 1005 / NA 22739

CONTINUOUS PATTERN

### FL CUBE VELVET Pearl Antigrav

2613 x 1005 / NA 22740

Please consider the nap direction of the surface before further processing or product installation. If design panels are not installed in the same direction, there will be a visual color difference.



Photo: © istock.com

2613 x 1005



## FABRIC-LINE POSITIVE ACOUSTIC EFFECT

# FL CUBE VELVET Antigrav

### Product characteristics

	NA
Base material	PP-glass fibres
Surface material	PET fibres
Material thickness mm	3,9
Max. relief height mm	6
Temperature stability	up to 60 °C
Wet room suitability	■■■■■
Rolled packable	—

### Processing

	NA
Cutting, punching	✓
Drilling	✓
Sawing	✓
Milling	—
Laser cutting	✓
Hot bending	—
PVA compressible	✓
Smallest bending radius	1000 mm

### Extra equipment

	NA
Special formats	On request
Cuttings	✓
Magnetic from 3 sheets *	✓
PVA pre-treatment	—

### Accessories

SIBUKLE	Spatula A2
---------	------------

### Special colors

On request
------------

\* Ground must be a SIBU metal foil SA (ref. 17637, self adhesive).





**LL LEGUAN Silver Antigrav**  
2600 x 1000 / **NA** 19781



**LL LEGUAN Gold Antigrav**  
2600 x 1000 / **NA** 19778



**LL LEGUAN Copper Antigrav**  
2600 x 1000 / **NA** 19777



**LL LEGUAN Nero Antigrav**  
2600 x 1000 / **NA** 19779



**LL LEGUAN Silk Antigrav**  
2600 x 1000 / **NA** 19780



**LL LEGUAN Bianco Antigrav**  
2600 x 1000 / **NA** 19775

## LEATHER-LINE

# LL LEGUAN Antigrav

### Product characteristics

	<b>NA</b>
Base material	PP-glass fibres
Surface material	PU-leather
Material thickness mm	3,4
Temperature stability	up to 60 °C
Wet room suitability	■■■□
Rolled packable	—

### Processing

	<b>NA</b>
Cutting, punching	✓
Drilling	✓
Sawing	✓
Milling	—
Laser cutting	✓
Hot bending	—
PVA compressible	✓
Smallest bending radius	1000 mm

### Extra equipment

	<b>NA</b>
Special formats	On request
Cuttings	✓
Magnetic from 3 sheets *	✓
PVA pre-treatment	—

### Accessories

SIBUKLE	Spatula A2
---------	------------

### Special colors

—
---

\* Ground must be a SIBU metal foil SA (ref. 17637, self adhesive).

CONTINUOUS PATTERN

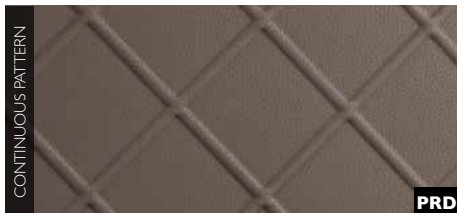


PRD

**LL CORD Stony Ground Antigrav**

2600 x 1000 / NA 19766

CONTINUOUS PATTERN

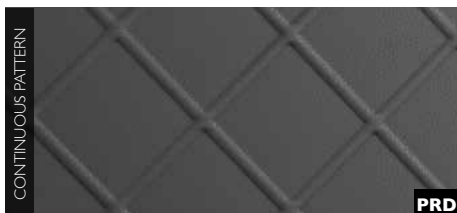


PRD

**LL CORD Dove Tale Antigrav**

2600 x 1000 / NA 19765

CONTINUOUS PATTERN



PRD

**LL CORD Charcoal Light Antigrav**

2600 x 1000 / NA 19764



□ LL CORD Dove Tale Antigrav

Photo: iStock.com

2600 x 1000



+ ▾

## LEATHER-LINE

**LL CORD Antigrav****Product characteristics**

	NA
Base material	PP-glass fibres
Surface material	PU-leather
Material thickness mm	3,8
Max. relief height mm	6,2
Temperature stability	up to 60 °C
Wet room suitability	■ ■ ■ ■
Rolled packable	—

**Processing**

	NA
Cutting, punching	✓
Drilling	✓
Sawing	✓
Milling	—
Laser cutting	✓
Hot bending	—
PVA compressible	✓
Smallest bending radius	1000 mm

**Extra equipment**

	NA
Special formats	—
Further thicknesses	—
Cuttings	✓
Magnetic from 3 sheets *	✓
PVA pre-treatment	—

\* Ground must be a SIBU metal foil SA (ref. 17637, self adhesive).

**Accessories**

SIBUKLE	Spatula A2
---------	------------

**Special colors**

On request
------------





□ LL Charcoal Dark Antigrav



**LL Charcoal Dark Antigrav**  
2600 x 1000 / **NA** 19762



**LL Charcoal Light Antigrav**  
2600 x 1000 / **NA** 19763



**LL Dove Tale Antigrav**  
2600 x 1000 / **NA** 19769



**LL London Clay Antigrav**  
2600 x 1000 / **NA** 19782



**LL Stony Ground Antigrav**  
2600 x 1000 / **NA** 19794

## LEATHER-LINE

# LEATHER-LINE Antigrav

### Product characteristics

	NA
Base material	PP-glass fibres
Surface material	PU-leather
Material thickness mm	3,8
Temperature stability	up to 60 °C
Wet room suitability	■■■■■
Rolled packable	—

### Processing

	NA
Cutting, punching	✓
Drilling	✓
Sawing	✓
Milling	—
Laser cutting	✓
Hot bending	—
PVA compressible	✓
Smallest bending radius	1000 mm

### Extra equipment

	NA
Special formats	On request
Further thicknesses	—
Cuttings	✓
Magnetic from 3 sheets *	✓
PVA pre-treatment	—

### Accessories

SIBUKLE	Spatula A2
---------	------------

### Special colors

On request
------------

\* Ground must be a SIBU metal foil SA (ref. 17637, self adhesive).





PRS\*

**DM CEMENT Dark Antigrav**  
2600 x 1000 / **NA** 19798



□  
DM CEMENT Dark Antigrav

Photo: © shutterstock.com

2600 x 1000



DECO-LINE

# DM CEMENT Dark Antigrav

## Product characteristics

	NA
Base material	PP-glass fibres
Surface material	impregnated paper
Material thickness mm	3,3
Temperature stability	up to 60 °C
Wet room suitability	■■■□
Abrasion resistance	■■■■□□
Rolled packable	—

## Processing

	NA
Cutting, punching	✓
Drilling	✓
Sawing	✓
Milling	—
Laser cutting	✓
Hot bending	—
PVA compressible	✓
Smallest bending radius	1000 mm

## Extra equipment

	NA
Special formats	On request
Further thicknesses	—
Cuttings	✓
Magnetic from 3 sheets **	✓
PVA pre-treatment	—

## Accessories

SIBUKLE	Spatula A2
---------	------------

## Special colors

—
---



□  
DM CEMENT Light Antigrav



PR+\*

**DM CEMENT Light Antigrav**  
2600 x 1000 / NA 19563

DECO-LINE

# DM CEMENT Light Antigrav

2600 x 1000

**Product characteristics**

	NA
Base material	PP-glass fibres
Surface material	impregnated paper
Material thickness mm	3,1
Temperature stability	up to 60 °C
Wet room suitability	■■■■□
Abrasion resistance	■■■■■□
Rolled packable	—

**Processing**

	NA
Cutting, punching	✓
Drilling	✓
Sawing	✓
Milling	—
Laser cutting	✓
Hot bending	—
PVA compressible	✓
Smallest bending radius	1000 mm

**Extra equipment**

	NA
Special formats	On request
Further thicknesses	—
Cuttings	✓
Magnetic from 3 sheets **	✓
PVA pre-treatment	—

**Accessories**

SIBUKLE	Spatula A2
---------	------------

**Special colors**

—
---

\* Prior to printing a corona or plasma treatment has to be carried out.  
Upon request available in pre-treated version.

\*\* Ground must be a SIBU metal foil SA (ref. 17637, self adhesive).

+ ▾



PRS\*

**DM Travertin Antigrav**  
2600 x 1000 / NA 19567



Photo: iStock.com

2600 x 1000



DECO-LINE

# DM Travertin Antigrav

## Product characteristics

	NA
Base material	PP-glass fibres
Surface material	impregnated paper
Material thickness mm	3,3
Temperature stability	up to 60 °C
Wet room suitability	■■■□
Abrasion resistance	■■■■□□
Rolled packable	—

## Processing

	NA
Cutting, punching	✓
Drilling	✓
Sawing	✓
Milling	—
Laser cutting	✓
Hot bending	—
PVA compressible	✓
Smallest bending radius	1000 mm

## Extra equipment

	NA
Special formats	On request
Further thicknesses	—
Cuttings	✓
Magnetic from 3 sheets**	✓
PVA pre-treatment	—

## Accessories

SIBUKLE	Spatula A2
---------	------------

## Special colors

—
---





PR+\*

**DM MARBLE White Antigrav**  
2600 x 1000 / NA 19566

DECO-LINE

# DM MARBLE White Antigrav

## Product characteristics

	NA
Base material	PP-glass fibres
Surface material	impregnated paper
Material thickness mm	3,1
Temperature stability	up to 60 °C
Wet room suitability	■■■■□
Abrasion resistance	■■■■■■□
Rolled packable	—

## Processing

	NA
Cutting, punching	✓
Drilling	✓
Sawing	✓
Milling	—
Laser cutting	✓
Hot bending	—
PVA compressible	✓
Smallest bending radius	1000 mm

## Extra equipment

	NA
Special formats	On request
Further thicknesses	—
Cuttings	✓
Magnetic from 3 sheets **	✓
PVA pre-treatment	—

## Accessories

SIBUKLE	Spatula A2
---------	------------

## Special colors

—
---

\* Prior to printing a corona or plasma treatment has to be carried out.  
Upon request available in pre-treated version.

\*\* Ground must be a SIBU metal foil SA (ref. 17637, self adhesive).

2600 x 1000



+ ▼



**DM CONCRETE Grey Antigrav**  
2600 x 1000 / NA 22829



Photo: iStock.com

2600 x 1000



## DECO-LINE

# DM CONCRETE Grey Antigrav

### Product characteristics

	NA
Base material	PP-glass fibres
Surface material	PP
Material thickness mm	3,3
Temperature stability	up to 60 °C
Wet room suitability	■■■□
Abrasion resistance	■■■■■■
Rolled packable	—

### Processing

	NA
Cutting, punching	✓
Drilling	✓
Sawing	✓
Milling	—
Laser cutting	✓
Hot bending	—
PVA compressible	✓
Smallest bending radius	1000 mm

### Extra equipment

	NA
Special formats	On request
Further thicknesses	—
Cuttings	✓
Magnetic from 3 sheets**	✓
PVA pre-treatment	—

### Accessories

SIBUKLE	Spatula A2
---------	------------

### Special colors

—
---

\*\* Ground must be a SIBU metal foil SA (ref. 17637, self adhesive).



**WL OAK TREE Light Antigrav**  
2600 x 1000 / NA 19561

## WOOD-LINE

# WL OAK TREE Light Antigrav

2600 x 1000

### Product characteristics

	NA
Base material	PP-glass fibres
Surface material	impregnated paper
Material thickness mm	3,1
Temperature stability	up to 60 °C
Wet room suitability	■■■□
Abrasion resistance	■■■□□□
Rolled packable	—

### Processing

	NA
Cutting, punching	✓
Drilling	✓
Sawing	✓
Milling	—
Laser cutting	✓
Hot bending	—
PVA compressible	✓
Smallest bending radius	1000 mm

### Extra equipment

	NA
Special formats	On request
Further thicknesses	—
Cuttings	✓
Magnetic from 3 sheets**	✓
PVA pre-treatment	—

### Accessories

SIBUKLE	Spatula A2
---------	------------

### Special colors

—
---

\* Prior to printing a corona or plasma treatment has to be carried out.  
Upon request available in pre-treated version.

\*\* Ground must be a SIBU metal foil SA (ref. 17637, self adhesive).





PRS\*

**WL Nutwood Antigrav**  
2600 x 1000 / NA 19568



PRS\*

**WL Nutwood Country Antigrav**  
2600 x 1000 / NA 19569



PRS\*

**WL Maple Alpine Antigrav**  
2600 x 1000 / NA 19570



Photo: © fotolia.com

## WOOD-LINE

# WL Nutwood Antigrav

### Product characteristics

	NA
Base material	PP-glass fibres
Surface material	impregnated paper
Material thickness mm	3,3
Temperature stability	up to 60 °C
Wet room suitability	■■■□
Abrasion resistance	■■■■□□
Rolled packable	—

### Processing

	NA
Cutting, punching	✓
Drilling	✓
Sawing	✓
Milling	—
Laser cutting	✓
Hot bending	—
PVA compressible	✓
Smallest bending radius	1000 mm

### Extra equipment

	NA
Special formats	On request
Further thicknesses	—
Cuttings	✓
Magnetic from 3 sheets**	✓
PVA pre-treatment	—

### Accessories

SIBUKLE	Spatula A2
---------	------------

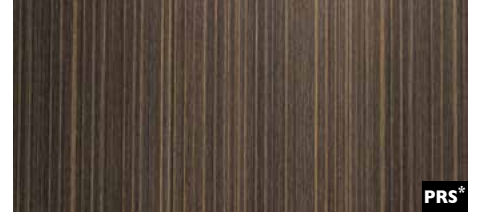
### Special colors

—
---



□  
WL Wenge Wood Antigrav

Photo: © fotolia.com



PRS\*

**WL Wenge Wood Antigrav**  
2600 x 1000 / NA 19571

## WOOD-LINE

# WL Wenge Wood Antigrav

2600 x 1000

### Product characteristics

	NA
Base material	PP-glass fibres
Surface material	impregnated paper
Material thickness mm	3,3
Temperature stability	up to 60 °C
Wet room suitability	■■■□
Abrasion resistance	■■■□□□
Rolled packable	—

### Processing

	NA
Cutting, punching	✓
Drilling	✓
Sawing	✓
Milling	—
Laser cutting	✓
Hot bending	—
PVA compressible	✓
Smallest bending radius	1000 mm

### Extra equipment

	NA
Special formats	On request
Further thicknesses	—
Cuttings	✓
Magnetic from 3 sheets**	✓
PVA pre-treatment	—

### Accessories

SIBUKLE	Spatula A2
---------	------------

### Special colors

—
---

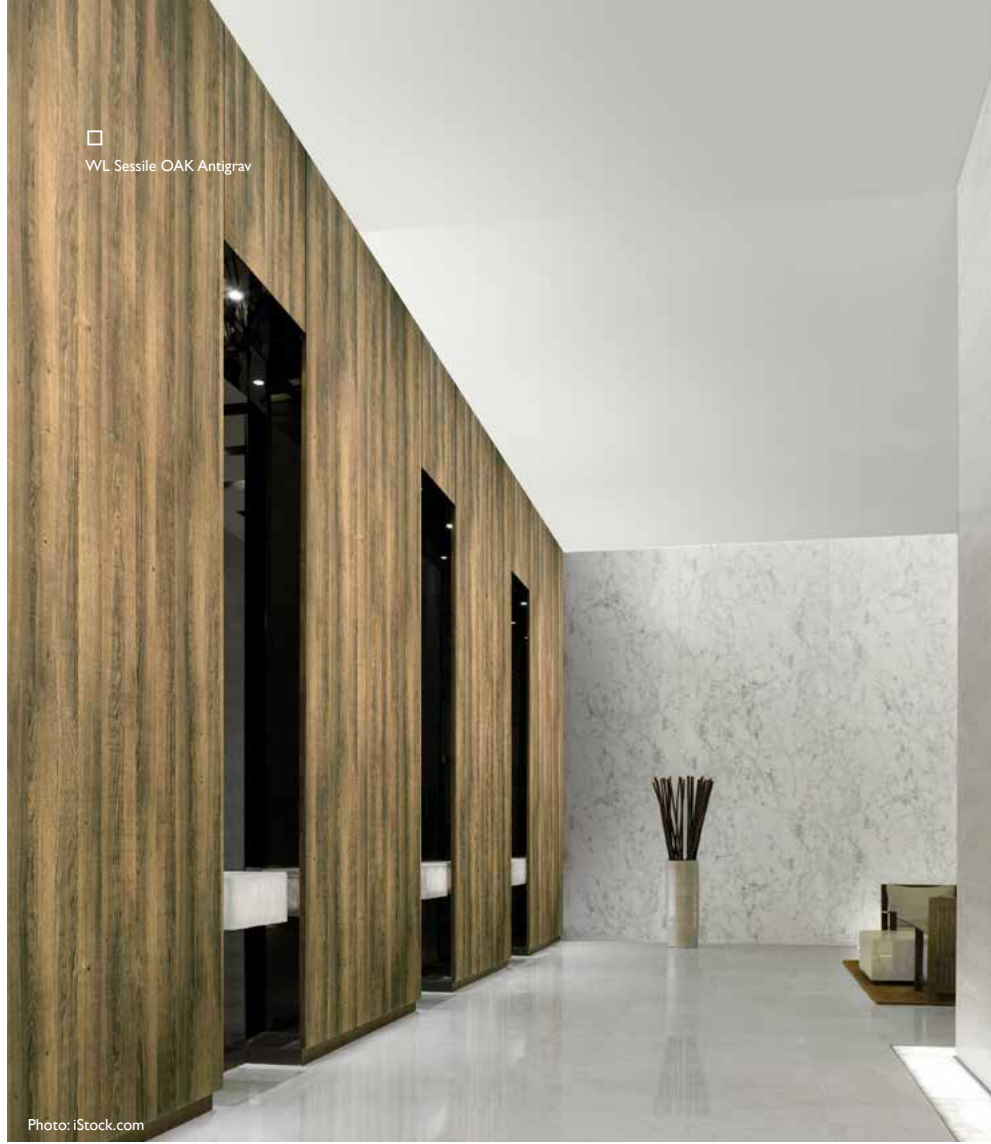
\* Prior to printing a corona or plasma treatment has to be carried out.  
Upon request available in pre-treated version.

\*\* Ground must be a SIBU metal foil SA (ref. 17637, self adhesive).



**WL Sessile OAK Antigrav**  
2600 x 1000 / NA 22785

PRS\*



□  
WL Sessile OAK Antigrav

Photo: iStock.com

2600 x 1000



+ ▼

## WOOD-LINE

# WL Sessile OAK Antigrav

### Product characteristics

	NA
Base material	PP-glass fibres
Surface material	impregnated paper
Material thickness mm	3,3
Temperature stability	up to 60 °C
Wet room suitability	■■■□
Abrasion resistance	■■■■□□
Rolled packable	—

### Processing

	NA
Cutting, punching	✓
Drilling	✓
Sawing	✓
Milling	—
Laser cutting	✓
Hot bending	—
PVA compressible	✓
Smallest bending radius	1000 mm

### Extra equipment

	NA
Special formats	On request
Further thicknesses	—
Cuttings	✓
Magnetic from 3 sheets**	✓
PVA pre-treatment	—

### Accessories

SIBUKLE	Spatula A2
---------	------------

### Special colors

—
---





□  
WL Carbonized Wood Antigrav



**WL Carbonized Wood Antigrav**  
2600 x 1000 / NA 20158

## WOOD-LINE

# WL Carbonized Wood Antigrav

2600 x 1000



### Product characteristics

	NA
Base material	PP-glass fibres
Surface material	impregnated paper
Material thickness mm	3,3
Temperature stability	up to 60 °C
Wet room suitability	■■■■□
Abrasion resistance	■■■■□□
Rolled packable	—

### Processing

	NA
Cutting, punching	✓
Drilling	✓
Sawing	—
Milling	—
Laser cutting	✓
Hot bending	—
PVA compressible	✓
Smallest bending radius	1000 mm

### Extra equipment

	NA
Special formats	On request
Further thicknesses	—
Cuttings	✓
Magnetic from 3 sheets**	✓
PVA pre-treatment	—

### Accessories

SIBUKLE	Spatula A2
---------	------------

### Special colors

—
---

\* Prior to printing a corona or plasma treatment has to be carried out.  
Upon request available in pre-treated version.

\*\* Ground must be a SIBU metal foil SA (ref. 17637, self adhesive).



# LEGENDE

PRODUCT CHARACTERISTICS

EXTRA EQUIPMENT

PROCESSING

ACCESSORIES

**STORAGE / TRANSPORT** GENERAL

**CLEANING / DISPOSAL** GENERAL



# Product characteristics

To answer your questions as quickly as possible, our team has worked out a technical table with product characteristics, extra equipment and much more for each of our products:

## BASE MATERIAL

As a base material we use a specially developed, highly impact resistant polystyrene type (HIPS). HIPS distinguish particularly by robustness, high impact and a very low weight. For our ACRYLIC-LINE we use as a base material ABS with acrylic surface. With PUNCH-LINE 3D products we use HIPS with background foil from APET.

Scratch-resistant PMMA is employed for the SIBUGLAS product group and PP glass fibre material is used for the ANTIGRAV range.

- HIPS = high impact polystyrene
- HIPS, PE foam = high impact polystyrene and Polyethylene foam
- ABS = Acrylonitrile butadiene styrene
- APET/HIPS = Amorphous polyethylene terephthalate and high impact polystyrene
- PP-glass fibre = Polypropylene with fiberglass
- PS = Polystyrene

Reverse side of SIBUGLAS and OPACO-LINE panels:

- PU-leather = Polyurethane synthetic leather surface
- Paper = printed paper

## MATERIAL THICKNESS

The given material thicknesses refer to the stock program in non adhesive (NA) and self adhesive (SA) version.

## SA SELF-ADHESIVE

SA - the back of the design sheet is equipped with an adhesive layer. For this we use high-quality acrylic adhesive substance or synthesis rubber (PUNCH-LINE 3D, MultiStyle).

In order to achieve maximum adhesion, always clean non-absorbent surfaces with alcohol (ethanol, isopropyl alcohol).

Self-adhesive (SA) sheets are ideally suited to non-absorbent surfaces such as coated MDF/chipboard, glass, metal, plastic, etc. However, they are unsuitable for use on ceilings. Alternative processing options are available on request.

## TOLERANCES

**Machine-related dimensional and angle tolerances:**

+/- 1.0 mm in relation to 1,000 mm

**Temperature-related dimensional deviations:**

+/- 0.7 mm in relation to 1,000 mm at a temperature change of 10 °C (except ANTIGRAV)

## ROLLED PACKABLE

Basically our design sheets are packed flat on pallets. However, in order to dispatch small consignments as favourably as possible, we have developed a packaging carton in which many of our design sheets can be packed rolled as well.

**Basically, the following applies:**

Design sheets in non-adhesive (NA) version are rolled with the decor side outwardly and design sheets in self-adhesive version (SA) are rolled with the glue side outwardly.

**Exceptions:**

LEATHER-LINE, FABRIC-LINE, DM DEEP BRUSHED and DM CONCRETE products as well as sheets with a magnetic film: always roll with the patterning on the outside.

PL3D, WOOD-LINE and DECO-LINE products with impregnated papers such as DM GENESIS Grey supermatt AR, DM GENESIS White supermatt AR, DM MARBLE White supermatt AR and DM MARBLE Black supermatt AR: always roll with the patterning on the inside.

**Packed in boxes (480x480 mm):**

Sheets with a magnetic film: we recommend a maximum of 2 pieces per box.

DECO-LINE products with impregnated paper as well as DM DEEP BRUSHED, DM CONCRETE, DM GENESIS Grey supermatt AR, DM GENESIS White supermatt AR, DM MARBLE White supermatt AR and DM MARBLE Black supermatt AR, LEATHER-LINE, FABRIC-LINE, PUNCH-LINE 3D and WOOD-LINE: we recommend a maximum of 3 pieces per box.

DECO-LINE (excluding products with impregnated paper as well as DM DEEP BRUSHED, DM CONCRETE, DM GENESIS Grey supermatt AR, DM GENESIS White supermatt AR, DM MARBLE White supermatt AR und DM MARBLE Black supermatt AR), WOOD-LINE, PUNCH-LINE, ACRYLIC-LINE, MSC and STRUCTURE-LINE products: we recommend a maximum of 6 pieces per box.

After receipt, rolled goods should be laid out flat for around 24 hours at room temperature and if necessary, subjected to additional weight.

## SURFACE MATERIAL

In a changeable world we focus on lastingness and high standards by using 100% PVC-free surfaces. We make a distinction between:

- **PU-leather** = Polyurethane synthetic leather surface / Artificial leather surfaces
- **PMMA** = Polymethyl methacrylate
- **PMMA AR+** = Polymethyl methacrylate with AR + scratch resistant coating
- **impregnated paper** = paper with protective varnish
- **Print**
- **PET** = Polyethylene terephthalate (UV lacquer for the AR version)
- **PET/Faser** = Polyethylene terephthalate (Artificial fur surfaces)

All variations are optically outstanding and also fascinate by their unique haptics. They correspond to the highest demands and they are suited especially for the interior area.

## MAXIMUM RELIEF HEIGHT

With the given data we define the highest position of the respective design in non-adhesive (NA) and adhesive (SA) version.

## PRINTING

Owing to the many differing printing and colour systems, customers must carry out a printing test. The result will depend on the respective motif. We will be pleased to provide original samples for testing.

### SIBU guideline values:

- PRD** digital printing possible
- PRS** screen printing possible
- PR+** digital/screen printing possible
- PR+\*** digital/screen printing possible, prior to printing a corona or plasma, treatment has to be carried out. By request available in pre-treated version.
- PRS\*** screen printing possible, prior to printing a corona or plasma, treatment has to be carried out. By request available in pre-treated version.

### SCREEN PRINTING:

The final adhesion performance will set in very slowly and can take up to one week on air-drying (20 °C.).

## TEMPERATURE STABILITY

We supply to more than 70 countries in the world and have nearly everywhere special climate situation. Therefore we test our material under the hardest conditions. Already during development stage our SIBU DESIGN sheets are tested in special thermo-containers stuck on ground as well as unstuck with high temperatures and high air humidity. Only the very best qualities correspond to our strict directives. The given data of the temperature stability refer to the lasting application of the product stuck on different grounds and to the long-term using temperature also without adhesion.

## WET ROOM SUITABILITY

An exposure of SIBU DESIGN sheets to humid areas is given when a design sheet is subjected to short term humidity condition. This humidity condition can occur by reason of high air humidity or by direct sprinkling water. SIBU DESIGN sheets are not suited for the direct wet space area as well as for long-term wet influence (except SIBUGLAS).

■■■■■ Wet room suitability

■■■■□ Wet room suitability, but material reacts more sensitively to sprinkling water. Removing of moisture is recommended.

## ABRASION RESISTANCE

Products with marked abrasion resistance **AR** show an extremely abrasion resistant surface. Our technology team already tests the products during development process to be able to offer the matching product for each of your demands.

■■■■■■■■■ Scratch resistant (SIBUGLAS AR+)

■■■■■■■ Excellent abrasion resistance

■■■■■■□ Very good abrasion resistance

■■■■□□ Good abrasion resistance

■■■■□□□ Normal abrasion resistance

■■□□□□ Low abrasion resistance

■□□□□□ Use only in the decoration area

## Extra equipment

We are aware of the fact that not always you can use our standard stock articles for your intended application and offer for you special extra equipment.

### FIRE CLASSIFICATION

The products from the stock program correspond to the fire safety regulations according to DIN 4102 B2, excluded products ACRYLIC-LINE (test standard: UL Standard 94, measured value: 94 HB). Marked products **FR** are available in flame retardant version on request, on a different carrier material. Manufacturer's certificate of compliance of the following standards are available: EN 13501-1 and ASTM E 84. Info sheets on demand!

### CUTTINGS

You want to get customized sheets or cuttings? Please contact us that we can offer the best possible solution to you. With a cutting length up to 3.2 meter and a punching and sawing length up to 3 meter we are able to meet your requirements and needs promptly.

### PVA PRE-TREATMENT

In order to be suitable for PVA bonding, depending upon the material thickness on the reverse side, SIBU DESIGN sheets either have to be pre-treated by means of an additional production process, or roughened by using a vibration sander (80-grain sandpaper).

Being able to carry out this pre-treatment for you in our factory, we absolutely need this information together with your order.

### SPECIAL FORMATS

In addition to the standard sizes given in the OVERVIEW we offer with pleasure individually adapted product dimensions.

### FURTHER THICKNESSES

Responding to your request we produce our DECO-LINE and PUNCH-LINE in thicknesses between 0.8 and 4.0 mm.

### MAGNETIC

All SIBU DESIGN sheets are available with a magnetic back from 3 pieces onwards. Exception - all LL ROMBO, LL QUADRO, LL CRISTAL ROMBO, PUNCH-LINE and SIBUGLAS Hollywood.

SIBU magnetic foils are suitable on different metallic grounds and on magnetic colours. The exchange of design sheets thereby becomes a child's play! The application fields for the SIBU DESIGN magnetic program are nearly unlimited – for shop-window decoration, shop fitting and fair design or in the furniture area, decoration field and for all kinds of displays.

Self-adhesive SIBU metal film is employed when a suitable metallic ground is lacking. The metal film can be ordered as a sheet (2,600x1,000 mm) or roll (14 or 29 m)



# Processing (except SIBUGLAS, OPACO-LINE and ANTIGRAV)

Please note that SIBU DESIGN sheets always have to be processed from the decor side.

## SURFACE PROTECTION

A protective film (Polyethylene/PE) protects our surfaces against damages. This protective film should be removed only after the application of our design sheets.

The following products are delivered without a protective film:

DM MONSOON Vintage Brown and all products of the FABRIC-LINE.

## PUNCHING

Band steel cutting is recommended for design sheets in thickness from 1 up to 1.5 mm.

Please study the technical table in the OVERVIEW in order to see if this processing step is permissible for your product.

## DRILLING

All SIBU DESIGN sheets can be drilled from the decor side.

## MILLING

**For material up to 2 mm thickness:**

Cutter with 3 mm diameter, rotation speed from 12000 up to 24000 rpm, progressive feed up to 12 m/min.

**Decor side on top:**

milling cutter with a left-hand twist, cutting right.

**Decor side below:**

milling cutter with a right-hand twist, cutting right.

For material with a thickness of more than 2 mm, reduce the progressive feed and use a milling cutter with a larger diameter (6 mm).

## SMALLEST BENDING RADIUS

The given data refer to the smallest bending radius for concave or convex fixing. For all design sheets – with the exception of MultiStyle – all sheet edges must be fixed mechanically in any case! For MultiStyle there is no need for mechanical fixing!

## HOT BENDING

Heat up the SIBU DESIGN sheets from the backside – for both, internal and exterior angles.

Approximate parameters for material in 1mm thickness:

wire temperature: approx. 200°C, heating time: approx. 6-17 seconds - depending on the surface material.

For ACRYLIC-LINE, PUNCH-LINE, DECO-LINE, STRUCTURE-LINE and FABRIC-LINE design sheets hot bending is outwardly (decor outside = external angle) possible – hot bending inwards (decor inside = interior angle) is possible only with plain designs or with fine structures.

For deeper structures - no exact internal angle.

Hot bending with LEATHER-LINE design sheets is possible outwardly (decor outside = external angle), inwards (decor side inside = interior angle) only with plain LEATHER-LINE. Using structured leather designs it can happen that wrinkles may appear along the internal angles.

## CUTTING

SIBU DECO-LINE sheets with less than 2 mm thickness can be easily cut with a wallpaper knife. Simply notch the surface and break along the edge. For all other product lines and for DECO-LINE sheets up to 3 mm thickness the cutting pressure has to be increased. After cutting and breaking our self-adhesive (SA) design sheets as well as 3D PUNCH-LINE designs (NA + SA) the foil on the back side has to be cut separately. Always use well sharp knives.

## SAWING

**SIBU guideline values:**

Material thicknesses of up to 1 mm:  
HW 280x3.2 / 2.2x30 Z60 / 12.46-18.08 WZ

Thicker than 1 mm:

HW 250x3.2 / 2.2x30 Z40 / 19.63 WZ/FA

HW 250x3.2 / 2.2x30 Z40 / 19.63 FZ/TR

(speed 6000 rpm, progressive feed of up to 25 m/min).

For LEATHER-LINE / FABRIC-LINE:

HW 255x2.8 / 2.0x30 Z80 / 10.01 FZ WZ

(speed 6000 rpm, progressive feed of up to 10 m/min).

The best result with LEATHER-LINE and FABRIC-LINE is achieved with MDF underlay (4 mm) above and below, slow progressive feed and high speed.

\*HW (hard metal material), WZ/FA (alternating teeth/bevelled edge), FZ (flat teeth), TR (trapezoidal teeth)

## LASER CUTTING

All SIBU DESIGN sheets can be processed with standard lasers. The cutting speed conforms to the watt power of the laser.

Please refer to the technical data in our OVERVIEW brochure, if that processing step is permitted for that product.

## THERMOFORMING

With a variety of Deco-Line products light forming, by using flat and not sharp-edged tools, is possible (avoid sharp contours and use larger radii). With every new moulding test are to be made, in order to obtain ideal results. The tool must be adapted to the material.

Refer to the technical table in the OVERVIEW catalogue whether this processing step is suitable for your product or not.

## PVA-PRESSING

Non-adhesive design sheets from our DECO-LINE, LEATHER-LINE, FABRIC-LINE, STRUCTURE-LINE, ACRYLIC-LINE and ANTIGRAV series (with a few exceptions) are compressible with commercial PVA adhesives. The ground must be absorbent (MDF, chipboard, etc.)

In order to be suitable for PVA bonding, depending upon the material thickness on the reverse side, SIBU DESIGN sheets either have to be pre-treated by means of an additional production process, or roughened by using a vibration sander (80-grain sandpaper).

Should by reason of transport or stock conditions the design sheet not have a crease-free protective film, the film should be removed prior to pressing process. The pressure applied should amount to 2 kg/cm<sup>2</sup> (0.2 N/mm<sup>2</sup>), the temperature to approx. 45°C and the pressing time to around 10 minutes. The bonding of the balancing material and the design sheet should be done in a single working process.

During pressing onto an untreated particle board in 16 mm thickness, best results were achieved with a 1 mm polystyrene balancing sheet.

When pressing structured design sheets (STRUCTURE-LINE, ACRYLIC-LINE, FABRIC-LINE and LEATHER-LINE), a medium-hard sponge rubber mat with a thickness of approx. 5 mm should be used between the pressing sheet and the patterned side of the design sheet. This provides uniform pressure distribution and prevents undesirable crushing spots.

When using DECO-LINE sheets it is better to press without the sponge rubber mat. The mat could cause irregular optics in the mirror surface. If you want to have a perfect mirror result, ask us for design sheets in 2 mm thickness.

Following pressing allow the sheets to cool in a stack over night (about 16 hours). Cover the stack with a 19 mm plate so that the uppermost sheet also remains flat.

As a result of this type of processing, standard edges of plastic, aluminium or wood can be used! The PVA adhesive prevents the usual expansion of our design sheets due to the effect of increased temperature!

PVA pretreated products should be processed within the specified processing period (see PVA News Update at [www.sibu.at](http://www.sibu.at)).

## Accessories

### SIBUKLE D22HV

#### **Solvent-free dispersion adhesive**

The best suitable spatula size A1 or A2 is given for each product.

Applications: SIBUKLE is highly suitable for the bonding of SIBU products onto absorbent, flat surfaces such as wood, plywood, particleboard, gypsum plasterboard, concrete or smooth brickwork.

WARNING: SIBUKLE is entirely unsuitable for non-absorbent surfaces such as tiles, plastics, metals, glass, etc.

Please follow the processing guidelines on the adhesive label.

## Storage / Transport

### STORAGE INSTRUCTIONS

SIBU DESIGN sheets must always be kept in indoor stock, no storage outside! Following instructions are to be considered:

- Design sheets to be stored flat, rolled packed design sheets should be unpacked and laid out flat and - if necessary - subjected to additional weight to improve flatness (Use carton underlay and weigh down the entire sheet in order to prevent damage.)
- Store the uppermost plate in the pile with decor side down.
- Protect SIBU products from UV rays.
- Do not expose SIBU products to moisture or humidity.
- Protect material from dirt, dust and mechanical damages.
- A permanent storage of more than 3 months at a temperature less than 0 °C or more than +30 °C may impact the quality of our design sheets and should be avoided.

### TRANSPORT INSTRUCTIONS

In general, for the transport of SIBU products pay attention to protect them from dirt, UV radiation, moisture and mechanical damages.

- Use stable, flat pallets with carton bedding, the pallet should be longer than the design sheets.
- Place the uppermost design sheet on the pallet with the decor side face down. This uppermost design sheet should be protected in addition by a carton and a board (e.g., chipboard, HDF...).
- The design sheets should be protected from shifting.
- The edges and sides must be also protected (edge protection, PE foil ...)
- Avoid temperatures below – 35 °C or more than + 50 °C.
- Structured sheets to be transported on pallets with the patterns running in same direction.
- SIBU products must be acclimatized prior to processing; ideal processing temperature is approx. + 10 °C to + 30 °C.
- Before any processing of the design sheets read the attached processing instructions which you can also find on the SIBU website!
- SIBUKLE should not be long-time stored below + 5 °C and must be protected from frost during transportation.
- Rolled packable: please see page 170

## Cleaning / Disposal

### CLEANING

**Do not use abrasive cleaners, solvent cleaners or pure alcohol!**

**DECO-LINE, STRUCTURE-LINE, ACRYLIC-LINE, PUNCH-LINE, PUNCH-LINE 3D:** in case of light dirt by means of soft cleaning cloth (it should be free of dust and free of dirt). In case of heavy dirt by means of standard plastic or window cleaner (spray cleaners not onto the material surface, but sparingly onto the cleaning cloth).

**LEATHER-LINE:** Clean leather surfaces by means of standard liquid soap and then remove the soap with a humid cloth.

**FABRIC-LINE:** Stains caused by oil, greases and ink must be removed immediately. Vacuum the surface in case of low pollution; in case of heavy pollution, dab the stain with an absorbent cloth, then wipe it off with mild soapy water.

### DISPOSAL

The keeping of healthy environment has high priority for us! We check all raw materials used for their environmental compatibility. Because not everyone has its own plastic disposal container, we pay special attention in development of new products to use only high-quality materials: materials, which may be disposed safely with the domestic waste. On demand we are pleased to provide LGA certificates for all SIBU DESIGN sheets.





**PROCESSING** INSTRUCTIONS GENERAL  
**PROCESSING** INSTRUCTIONS  
SIBUGLAS / OPACO-LINE  
**PROCESSING** INSTRUCTIONS **ANTIGRAV**

# Processing information general

(except SIBUGLAS, OPACO-LINE und ANTIGRAV)

## GROUND PREPARATION FOR GLUING

The ground must be dry and smooth, and free from loose material, dust, dirt, grease, wax and silicone. SIBU DESIGN patterned sheets should never be mounted onto an uneven surface, as this results in a loss of visual quality.

In the case of convex and concave surfaces, the sheet edges must be fixed mechanically (except for MultiStyle).

### **Non-absorbent surfaces**

In order to achieve maximum adhesion, always clean non-absorbent surfaces with alcohol (ethanol, isopropyl alcohol).

Self-adhesive (SA) sheets are ideally suited to non-absorbent surfaces such as coated MDF/chipboard, glass, metal, plastic, etc. However, they are unsuitable for use on ceilings. Alternative processing options are available on request.

### **Absorbent surfaces**

A solvent-free adhesive, which is suitable for both the underlying surface and the polystyrene material (base material), must be employed on absorbent grounds, e.g. uncoated chipboard, MDF, plasterboard, or smoothed brickwork. SIBU DESIGN recommendation: SIBUKLE.

## BONDING

Patterned sheets delivered in rolled form must be kept flat for a minimum of 24 hours. Weighing down improves evenness.

Ideal processing temperatures range from + 10°C up to + 30°C. The design sheets should be acclimatised, i.e. be brought to room temperature prior to processing (avoidance of condensation on the gluing surface and a reduction in sheet expansion due to reduced temperature differences).

A temperature increase of 10°C will cause our products to expand by approx. 0.7 mm over a length of 1 meter. As a rule, expansion gap of approx. 2 – 3 mm should be kept at each sheet edge!

In case of high surroundings temperature or major temperature-fluctuations the expansion gap should be increased or the sheet format should be chosen smaller.

Remove the backing cover step-by-step from self-adhesive design sheet (SA), do not touch gluing surface and press the sheet onto the ground as firmly as possible. Avoid blistering (air inclusions); use a medium-hard hand rubber roller with a width of approx. 170 mm. The final adhesion power will be reached at room temperature after 24 hours.



## PROCESSING SIBUKLE

**Application:** SIBUKLE is ideally suited to the bonding of SIBU DESIGN products onto absorbent, even surfaces such as wood, MDF, plywood, chipboard, plasterboard, or smooth brickwork. The underlying surface must be absorbent (MDF, chipboard, etc.).

**WARNING!** SIBUKLE is not suitable for non-absorbent grounds such as tiles, plastics, metals and glass, etc.

As a rule, an approx. 2 to 3 mm expansion joint is to be left along the sheet edges!

**Processing:** Apply only to the cleaned surface, which has been prepared for bonding, using a fine spatula (the spatula toothing for every product is provided in the OVERVIEW catalogue). With an ambient temperature of between 20 °C and 35 °C, the adhesive should then be left to air for 20 to 40 minutes. No drying time is required for PNL products, which are to be bonded in a wet adhesive bed. Fix mechanically if necessary, until the adhesive has hardened.

The higher the ambient temperature, the shorter is the airing time.

Finger test: following application with the spatula, the optimal airing time is reached as soon as the adhesive no longer sticks to the fingers!

Avoid the formation of bubbles (air inclusions) and use a medium-hard, rubber roller with a width of approx. 170 mm.

If other solvent-free dispersion adhesives are employed, the respective processing instructions are to be followed.

**Storage:** In the original airtight containers the adhesive can be stored up to 12 months from delivery date. Store always above freezing point. Protect from frost, otherwise the glue cannot be used anymore!

## GROUNDINGS – BONDING – EXPANSION GAPS

The ground must be dry and smooth, and free from loose material, dust, dirt, grease, wax and silicone. SIBU patterned sheets should never be mounted onto an uneven surface, as this results in a loss of visual quality.

In the case of convex and concave surfaces, the sheet edges must be fixed mechanically.

### Non-absorbent surfaces:

In order to achieve maximum adhesion, always clean non-absorbent surfaces with alcohol (ethanol, isopropyl alcohol).

Self-adhesive (SA) sheets are ideally suited to non-absorbent surfaces such as coated MDF/chipboard, glass, metal, plastic, etc. However, they are unsuitable for use on ceilings. Alternative processing options are available on request.

### Absorbent surfaces:

A solvent-free adhesive, which is suitable for both the underlying surface and the polystyrene material, must be employed on absorbent grounds, e.g. uncoated chipboard, MDF, plasterboard, or smoothed brickwork. Sibu recommendation: SIBUKLE D22 HV.

Ideal processing temperatures range from + 10 °C to + 30 °C. The design sheets must be acclimatised, i.e. be brought to room temperature prior to processing (avoidance of condensation on the gluing surface and a reduction in sheet expansion due to reduced temperature differences).

A temperature increase of 10 °C will cause our products to expand by approx. 0.7 mm over a length of 1 m.

As a rule, an approx. 2-3 mm expansion joint is to be left along the sheet edges!

In the case of high ambient temperatures, or major temperature fluctuations, the expansion gap should be increased, or a smaller sheet format selected.

Remove the paper backing from the reverse side of self-adhesive patterned sheets (SA) step-by-step. Do not touch the adhesive surface and press the sheet onto the ground as firmly as possible. Avoid the formation of bubbles (air inclusions) and use a medium-hard, rubber roller with a width of approx. 170 mm.

Full adhesion will be reached at room temperature after 24 hours.

Whenever possible, SIBU DESIGN products should be processed within 12 months (except for PVA pre-treated products, please see the PVA news update at [www.sibu.at](http://www.sibu.at)).

They are not recommended for use near open fires or sources of intense heat.

## BONDING USING SIBUKLE

SIBUKLE is suitable for the bonding of SIBUGLAS AND OPACO-LINE products on absorbent, level surfaces such as wood, plywood, chip-and plasterboard, concrete or smoothed masonry. PLEASE NOTE: SIBUKLE is totally unsuitable for non-absorbent surfaces such as tiles, plastic coverings, metal, glass, etc.

Processing: once the ground surface for laying has been prepared and cleaned, fully cover it alone with adhesive using a spatula with A2 teeth and then press down. It is essential that products be bonded in a bed of wet adhesive. When required fix mechanically until the adhesive has hardened. Please follow the processing guidelines on the adhesive label.

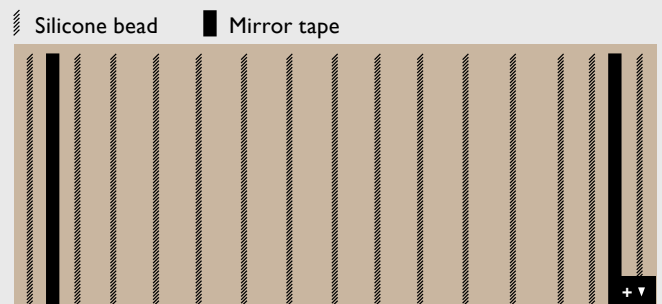
## BONDING & POINTING WITH SIBU SILICON

(Acetic acid free, textured natural stone silicone)

### Bead bonding:

On the reverse side of the sheet: vertical positioning of a silicone bead at a distance of 10 mm from the edge of the sheet or the profile leg, then position a mirrored adhesive tape at a distance of 10 mm. It is recommended that the protective strip on the mirrored tape be removed prior to the further processing phases.

Apply vertical beads of adhesive to the reverse side of the sheet at intervals of approx. 10 mm to the mirrored adhesive tape. (Depending on the underlying surface, the beads should have a height of at least 4 mm.) Apply the other silicone beads at a distance of 60 mm.



The illustration does not show the entire length of the panel

Bring the sheet into position without any drying time and then press it down onto the prepared surface by means of vertical strokes with a soft wallpaper roller.

The gluing can also be done without mirror adhesive tape!

Advantage: The sheet can be positioned much easier.

Disadvantage: The sheet has to be temporarily attached until the silicone beads have cured in order to prevent the plate from slipping unintentionally.

Once the adhesive has hardened, the joints can be sealed with silicone.

Immediately remove the protective film from the sheet and any possible adhesive residues.

## PVA BONDING

(please see page 184)

## MAGNETIC

With the magnetic finish professional decoration changes become a child's play. Deliveries can be made for orders of three sheets and upwards. Any surfaces suitable for magnets can be used as a ground and should these be unavailable, SIBU METALFOIL provides the solution.

## SURFACE PROTECTION

All the top surfaces are safeguarded against damage by a protective film (Polyethylen/PE), which should first be removed following processing.

## GOLDEN RULES

As a rule, complete processing on the patterned side (for this reason jig- and hand-held circular saw working must take place on the reverse side).

It is imperative that sheet flapping be avoided totally during all working phases.

Always lay the sheets out flat and if necessary pin them down.

Select the speed and feed that are adapted to the saw blade. Use sharp cutting tools!

The generation of heat should be constantly avoided, as this can result in material tension.

## MECHANICAL PROCESSING OF THE PATTERNED SHEETS PRIOR TO ADESIVE APPLICATION

### Sawing

Sheets can be cut with jig, hand-held circular, panel and circular table saws. During cutting on the reverse side, the underlay should also be sawn through. Then deburr all cut edges.

- **Cutting to length using a hand-held or plunge cut circular saw**

Cut from the reverse side and use a stable underlay.

Recommended saw blade: 160x2.2 hard metal blade with 48 alternating teeth.

- **Cutting to length using a jigsaw**

Set the pendulum action to zero, or at a maximum to I and then saw from the reverse side.

The patterned sheet must lie fully on the jigsaw cutting table in order to ensure that no vibrations are created.

Recommended saw blade: employ saw blades with a tooth pitch of 1.2 to max. 2.5 mm. (coarse metal saw blade / fine wood saw blade / preferably PMMA saw blades).

### Drilling

All drillings must be carried out on a stable underlay.

Recommended drill: wood drill (centring tip drill), Forstner drill and hard metal drill with centring tip.

Core drills for wood or hole saws (BI-metal) can also be used. Fix the design sheet on a stable surface.



## FLAMMABILITY

SIBUGLAS / OPACO-LINE products are subject to standard flammability pursuant to EN 13501-1 Class E.

## LASER CUTTING

Design sheets can be processed using standard lasers. The cutting speed is in line with the laser wattage.

**Note:** Place the design sheet on the laser machine in such a way that its reverse side is on the machine's extraction side. As is the case with all standard PMMA products, it is recommended that following laser cutting the material be "tempered". The high temperature of the laser causes tension in the material, which can lead to cracking. Tempering equalises these tensions.

## PRINTING

SIBUGLAS: digital/screen printing possible

OPACO-LINE: screen printing possible. Prior to printing a corona or plasma treatment has to be carried out. On request available in pre-treated version.

Owing to the many differing printing and colour systems, customers must carry out a printing test. The result will depend on the respective motif. We will be pleased to provide original samples for testing.

## CLEANING / CARE

Standard household cleaners without scouring agents can be used.

## DISPOSAL

Current LGA certificates exist for SIBUGLAS and OPACO-LINE. We are pleased to make these available.

Private area: Sheets can be disposed of with the normal household refuse.

Commercial area: Sheets should be conducted to thermal disposal.

## STORAGE INFORMATION

Always store products dry and flat, and protect them against the effects of humidity.

Wrap the sheets in plastic together with a silicate cachet and seal carefully. This prevents possible ripples along the sheet edges due to moisture in the air.

Outdoor storage is not possible

**The following should be noted:**

In order to prevent damage, the card underlay should be used and weighed down over its entire area. The uppermost sheet in the stack should be stored face down.

In storage, design sheets must be protected against sunlight and do not expose to wetness of damp.

The material should also be safeguarded against dirt, dust and mechanical damage.

## TRANSPORT INFORMATION

When transporting SIBUGLAS / OPACO-LINE care should be taken that the sheets are protected against dirt, UV rays, moisture and mechanical damage.

Stable, flat pallets that are larger than the sheets are to be employed with a card underlay.

The uppermost sheet must lie on the pallet with the structured face down. In addition, this top sheet should be protected by card and a slatted frame.

The edges and the sides must also be safeguarded (edge protection, PE film, ...).

The temperatures below minus 35° C or above 50° C should not be exceeded.

# SIBUGLAS SA, OPACO-LINE SA - BONDED ONTO COATED WOOD BASED SHEETS INCLUDING EDGES AND MILLING

## MATERIAL REQUIREMENTS

### SIBU decorative sheet:

SA dimension: 2600 x 1000 mm, self-adhesive

### Wood based sheet:

Wood based sheet coated on both sides, dimensions:  
2600 x 1000 mm

### Counter-pressure:

Not required

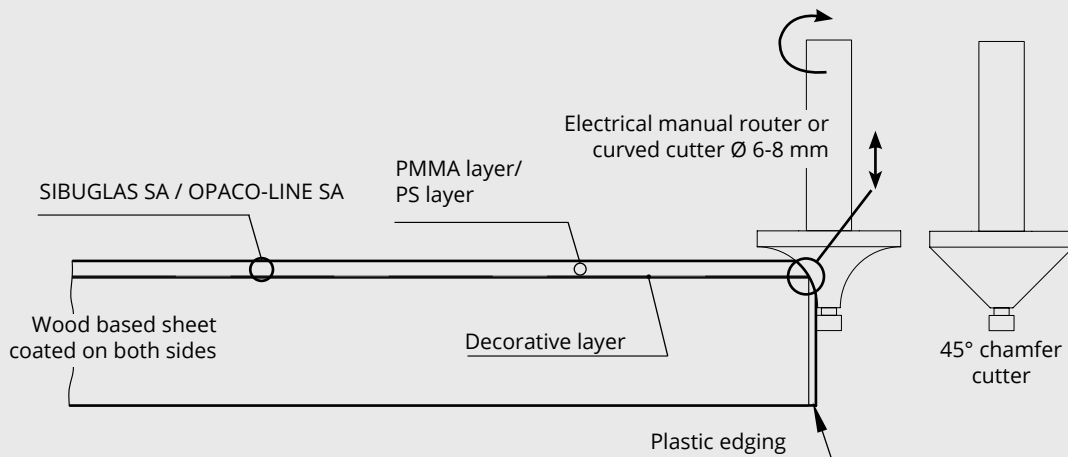
### Edge material:

All standard furniture edging

## PROCESSING STEPS

1. Clean the coated wood sheet.
2. Remove the protective film on the adhesive side of the design sheet.
3. Bond the design sheet onto the wood based sheet using a rubber roller.
4. Immediately cut the bonded sheets into the desired final dimensions (saw).
5. Place the edgings on the edge gluing machine.
6. **Using an electrical manual router, cut a rounded or chamfered edge exactly up to the point of transition from the transparent PMMA layer/PS layer to the structured layer. Please see sketch!** In combination, the edge material and the transparent PMMA layer/PS layer give the resultant radius or chamfer. The thicker the edge material, the wider the facet.

## FACET MILLING IS THE PREREQUISITE FOR AN EDGED END PRODUCT!



# SIBUGLAS AND OPACO-LINE PVA GLUED AND PRESSED ON ABSORBENT WOOD BASED SHEETS

Whether on home furniture, in display windows, bars, hotels, or trade fair stands, today SIBUGLAS and OPACO-LINE is used for a diversity of applications.

SIBUGLAS is a multilayer sheet comprised of PMMA, PU leather, a special synthetic leather or a special paper. The OPACO-LINE is a multilayer sheet comprised of a matt polyester surface, a polystyrene carrier and a special paper. This multilayer sheets can be bonded onto absorbent surfaces using PVA white glue. In order to ensure optimum flatness, we also deliver an accompanying, technically matching balancing sheet.

## PROCESSING

Both reverse sides (design and balancing sheet) are saturated with PVA white glue as evenly and quickly as possible using a roller. They are then laid on both sides of the absorbent wood based sheet and this composite is subsequently placed in a sheet press.

## DESCRIPTION – STRUCTURE

**SIBUGLAS / OPACO LINE decorative sheet** \_\_\_\_\_

**PVA white glue** \_\_\_\_\_

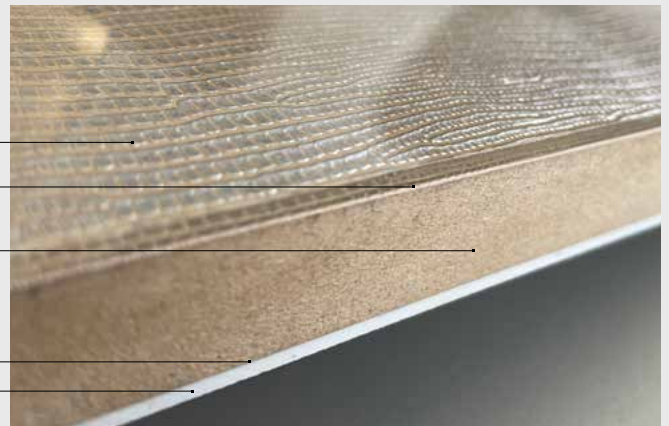
**Wood based sheet** \_\_\_\_\_

minimum thickness of 16 mm!

Use thicker wood based sheets for larger formats!

**PVA white glue** \_\_\_\_\_

**Balancing sheet** \_\_\_\_\_



Decorative sheets that have been glued and pressed in this manner can be easily processed with the majority of woodworking machinery and tools with good results. The PE protective film must be left on the top surface during processing. Optimum machine parameters, tool layout and cutting speeds are to be determined individually prior to production on the basis of a sample.



## BONDING INSTRUCTIONS FOR SIBUGLAS SHEETS WITH PVA WHITE GLUE

### **Glue application: only use flat, wood based sheets!**

The acclimatised design and balancing sheets, as well as the wood based sheet, should be laid out adjacent to one another on a straight, clean and sufficiently large work table. The wood based sheet must be roughly cut 10mm larger than the design sheets / balancing sheets. **Both sheets - the design sheet and the balancing sheet - should first be generously coated with PVA glue using a roller.** Owing to the highly absorbent reverse side, the consumption of PVA white glue is considerable. Subsequently, both sheets (design sheet and balancing sheet) are positioned as quickly as possible on the middle of the wood based sheet.

**! Warning! Glue should not be applied directly to the wood based sheet, as this can have a negative effect on evenness!**

### **Pressing:**

The composite sheet is now placed in the press for approx. 30 minutes at 30° C. Do not apply excessive pressure and take into account both your know-how and the values gained from personal experience. Standard value: 20 N/cm<sup>2</sup> or 2 kg/cm<sup>2</sup>.

As soon as the sheets are removed from the press, they must be stored under **stacking pressure for at least 12 hours in a FLAT position.** A genuinely even surface is extremely important for the flatness of the composite sheet!

A second possibility for small batches is to press the sheets in the machine overnight at approx. 20° C. This type of processing eliminates the need for subsequent stack pressure.

**Always clean the press thoroughly prior to processing sheets!**

**Cutting to length/edge trimming and other processing steps:**

**With standard woodworking machines:**

Recommendation: Fine cut saw blades

At the earliest, complete this work 12 hours after gluing/pressing!

**Edging application:** As usual, any standard edging can be mounted in the familiar manner!

## BALANCING SHEET

A technically matching balancing sheet is required for the glued and pressed composite (surface + wood based sheet + counter-pressure) that is ideally matched to the characteristics of the materials used. This virtually rules out warping due to heat, cold or fluctuating humidity.

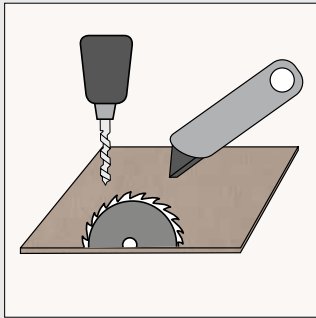
For SIBUGLAS and OPACO-LINE (PMMA 2 mm) we recommend the use of the **PMMA Balance Sheet White 2800x1250x2** (article number: 20278) for balancing.

If the PMMA Balance Sheet White has not been pressed within six months, we recommend a check on the surface tension of the reverse side and if required, its subsequent surface treatment.

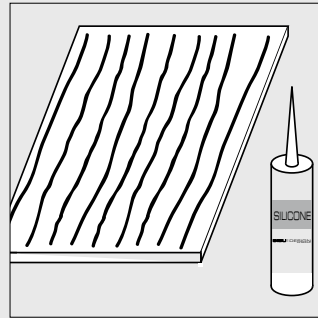
# Processing ANTIGRAV

## Standard processing

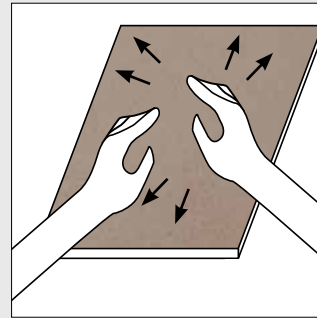
ANTIGRAV can be bonded edge to edge and therefore does not require expansion joints.  
Readjustment on **any surface** is no problem when bonding with standard silicon or hybrid polymer adhesive is employed.  
ANTIGRAV can be cut to size by using standard cutting-tools. Processing to be executed from the patterned side.



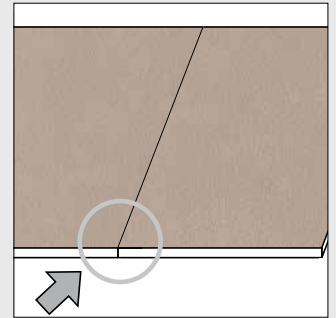
Processing to be executed from the patterned side.



Apply beads of silicone vertically (1cm from the edge and with 6cm-spaces between the individual beads).



Press the sheet onto the wall and then adjust it.



Bonding butt to butt = 0mm expansion joint

**NA**

non-adhesive

**SA**

self-adhesive

**FR**

flame-retardant version available on request

**PRD**

digital printing possible

**PRD\***

digital printing possible

Prior to printing a corona or plasma treatment has to be carried out.

By request available in pre-treated version.

**PRS**

screen printing possible

**PRS\***

screen printing possible

Prior to printing a corona or plasma treatment has to be carried out.

By request available in pre-treated version.

**PR+**

digital/screen printing possible

**PR+\***

digital/screen printing possible

Prior to printing a corona or plasma treatment has to be carried out.

By request available in pre-treated version.

■■■■

wet room suitability

■■■■□

limited suitability for wet rooms

**AR**

abrasion-resistant

**AR+**

scratch-resistant

**+ V**

entire panel length not shown  
in image

**Continuous pattern**

Continuous pattern

**SIBU | DESIGN**



# SIBU | DESIGN

**SIBU DESIGN GmbH & Co KG**

Jupiterstraße 8 / 4452 Ternberg, Austria

T. 0043 (0) 7256 / 6025-0 / F. 0043 (0) 7256 / 7020

[info@sibu.at](mailto:info@sibu.at) / [www.sibu.at](http://www.sibu.at)